

CHAMBERLAIN

# POWER DRIVE®

## 1/2 hp Chain Drive Garage Door Opener

FOR RESIDENTIAL USE ONLY

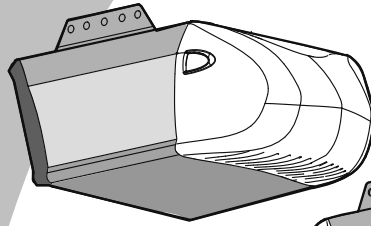

PD210 • PD212D •  
PD300 • LW2000 •  
HD200D • 248730

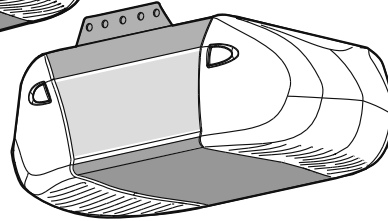

PD610D • PD612D •  
HD400D • LW3000

There are two types of garage door openers pictured.  
Yours may appear slightly different.

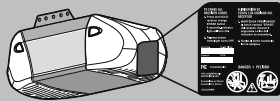

Write down the following information  
for future reference:

Serial Number:

Date of Purchase:

- Please read this manual and the enclosed safety materials carefully!
- Fasten the manual near the garage door after installation.
- The door **WILL NOT CLOSE** unless the Protector System® is connected and properly aligned.
- Periodic checks of the garage door opener are required to ensure safe operation.
- The model number label is located on the front panel of your garage door opener.

## CONTENTS

Preparation .....	1-4
Assembly.....	5-9
Installation.....	10-19
Install the Door Control .....	20-21
Install the Protector System® .....	22-25
Power.....	26-27
Adjustments .....	28-30
Operation.....	31
Using Your Garage Door Opener .....	32
Using the Wall-Mounted Door Control .....	32
To Open the Door Manual .....	33
Care of Your Opener.....	33
Having a Problem? .....	34
Diagnostic Chart .....	35
Programming .....	36-37
The Remote Control Battery.....	38
Accessories .....	39
Warranty .....	40-41
Repair Parts .....	42-43



www.chamberlain.com

The Chamberlain Group, Inc.  
845 Larch Avenue  
Elmhurst, Illinois 60126-1196

# Preparation

## Safety Symbol and Signal Word Review

This garage door opener has been designed and tested to offer safe service provided it is installed, operated, maintained and tested in strict accordance with the instructions and warnings contained in this manual.

When you see these Safety Symbols and Signal Words on the following pages, they will alert you to the possibility of **serious injury or death** if you do not comply with the warnings that accompany them. The hazard may come from something mechanical or from electric shock. Read the warnings carefully.

**⚠ WARNING**

**Mechanical**

**⚠ WARNING**

**Electrical**

When you see this Signal Word on the following pages, it will alert you to the possibility of damage to your garage door and/or the garage door opener if you do not comply with the cautionary statements that accompany it. Read them carefully.

**CAUTION**

## Check the Door

**⚠ WARNING**

To prevent possible **SERIOUS INJURY** or **DEATH**:

- ALWAYS call a trained door systems technician if garage door binds, sticks, or is out of balance. An unbalanced garage door may NOT reverse when required.
- NEVER try to loosen, move or adjust garage door, door springs, cables, pulleys, brackets or their hardware, ALL of which are under **EXTREME** tension.
- Disable ALL locks and remove ALL ropes connected to garage door **BEFORE** installation and operating garage door opener to avoid entanglement.

**CAUTION**

To prevent damage to garage door and opener:

- ALWAYS disable locks **BEFORE** installing and operating the opener.
- ONLY operate garage door opener at 120 V, 60 Hz to avoid malfunction and damage.

1. Disable locks and remove any ropes connected to the garage door.
2. Lift the door halfway up. Release the door. If balanced, it should stay in place, supported entirely by its springs.
3. Raise and lower the door to check for binding or sticking. If your door binds, sticks, or is out of balance, call a trained door systems technician.
4. Check the seal on the bottom of the door. Any gap between the floor and the bottom of the door must not exceed 1/4 inch (6 mm). Otherwise, the safety reversal system may not work properly.
5. The opener should be installed above the center of the door. If there is a torsion spring or center bearing plate in the way of the header bracket, it may be installed within 4 feet (1.2 m) to the left or right of the door center. See page 13.

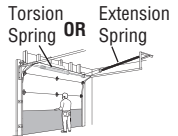

# Preparation

## Additional Items You May Need:

Survey your garage area to see if you will need any of the following items:

- **(2) 2X4 PIECES OF WOOD**  
May be used to fasten the header bracket to the structural supports. Also used to position the garage door opener during installation and for testing the safety reversing sensors.
- **SUPPORT BRACKET AND FASTENING HARDWARE**  
Must be used if you have a finished ceiling in your garage.
- **EXTENSION BRACKETS (MODEL 41A5281) OR WOOD BLOCKS**  
Depending upon garage construction, extension brackets or wood blocks may be needed to install the safety reversing sensor.
- **FASTENING HARDWARE**  
Alternate floor mounting of the safety reversing sensor will require hardware not provided.
- **OUTSIDE QUICK RELEASE (MODEL 7702CB)**  
Required for a garage with NO access door.
- **DOOR REINFORCEMENT**  
Required if you have a lightweight steel, aluminum, fiberglass or glass panel door.
- **RAIL EXTENSION KIT**  
Required if your garage door is more than 7 feet (2.13 m) high.

## Tools Needed

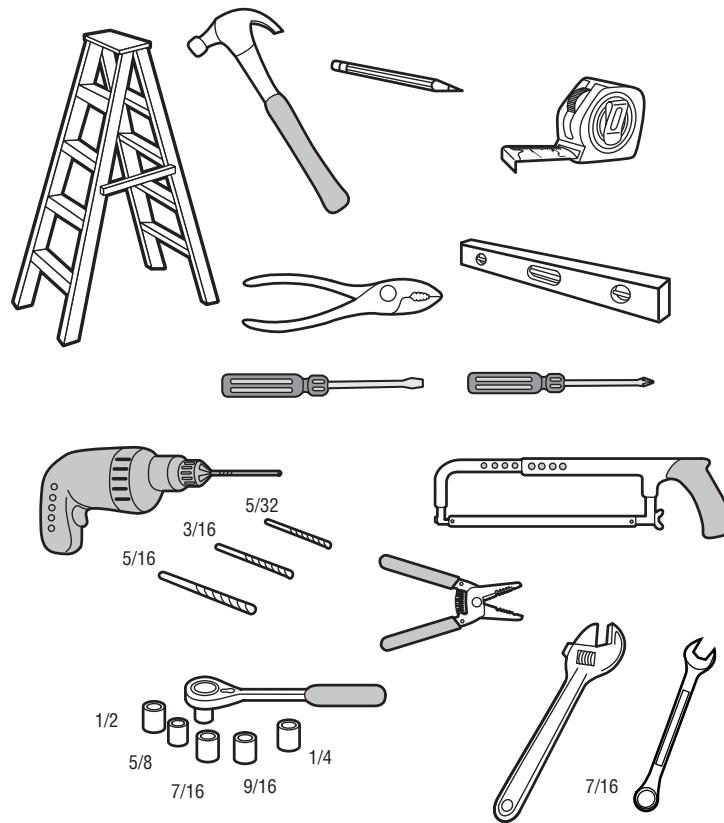

# Preparation

## Carton Inventory

Your garage door opener is packaged in one carton which contains the motor unit and all parts illustrated below. Accessories vary depending on the garage door opener model purchased. Depending on your model, other accessories may be included with your garage door opener. Instructions for these accessories will be attached to the accessory and are not included in this manual. If anything is missing, carefully check the packing material. Hardware for assembly and installation is shown on the next page.

Save the carton and packing material until the installation and adjustment is complete. The images throughout this manual are for reference only and your product may look different.

- A. Header bracket
- B. Pulley
- C. Door bracket
- D. Curved door arm
- E. Straight door arm (Packaged inside front rail section)
- F. Trolley
- NOTE:** Be sure to assemble the trolley before sliding onto rail.
- G. Emergency release rope and handle
- H. Rail (1 front and 4 center sections)
- I. Hanging brackets (2) (Packaged inside the front rail section)
- J. Garage door opener (motor unit)
- K. Chain spreader with screws
- L. "U" bracket
- M. Chain and cable
- N. Door control (Door Control Button or Multi-Function Door Control)
- O. Remote control
- P. **The Protector System®**  
Safety reversing sensors with 2 conductor white and white/black wire attached: Sending Sensor (1), Receiving Sensor (1), and Safety Sensor Brackets (2)
- Q. Keyless Entry (Depending on the model purchased)

### NOT SHOWN

- White and red/white wire
- Owner's manual

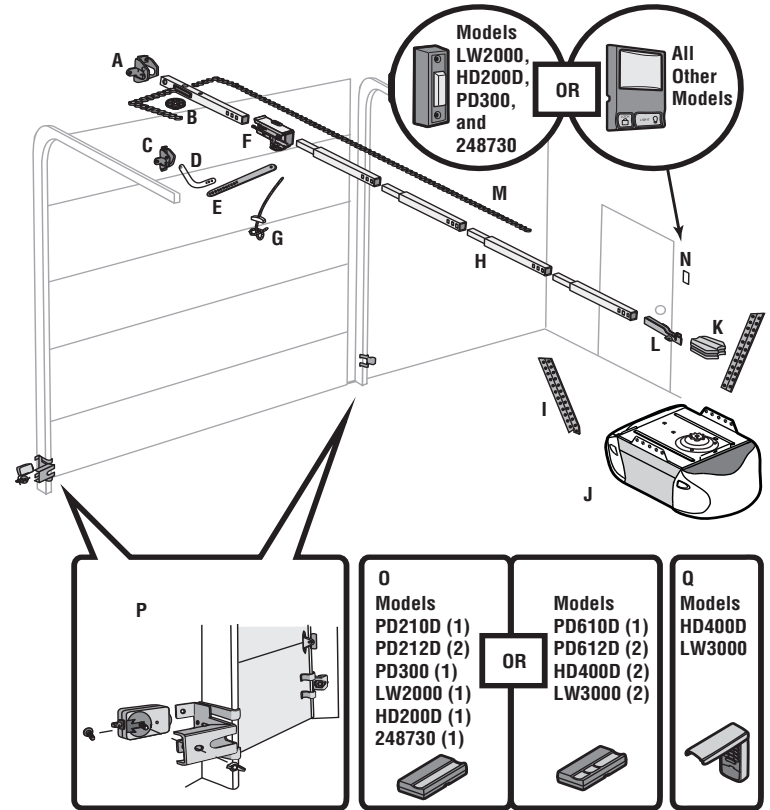

# Preparation

## Hardware Inventory

### ASSEMBLY HARDWARE

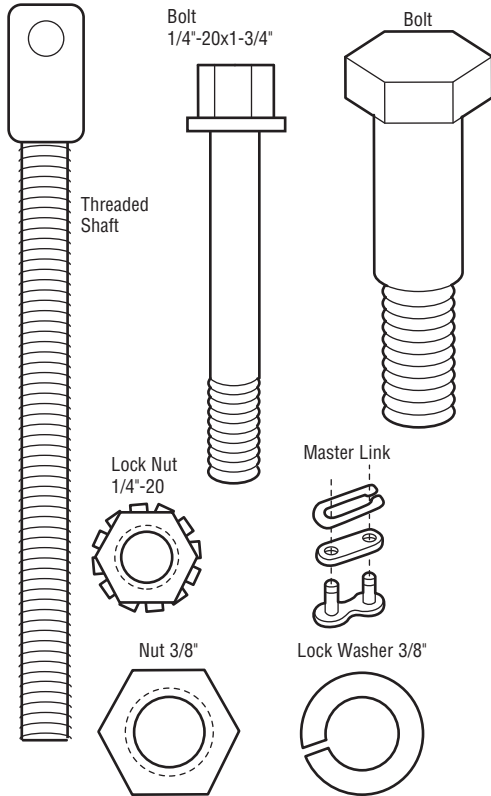

### INSTALLATION HARDWARE

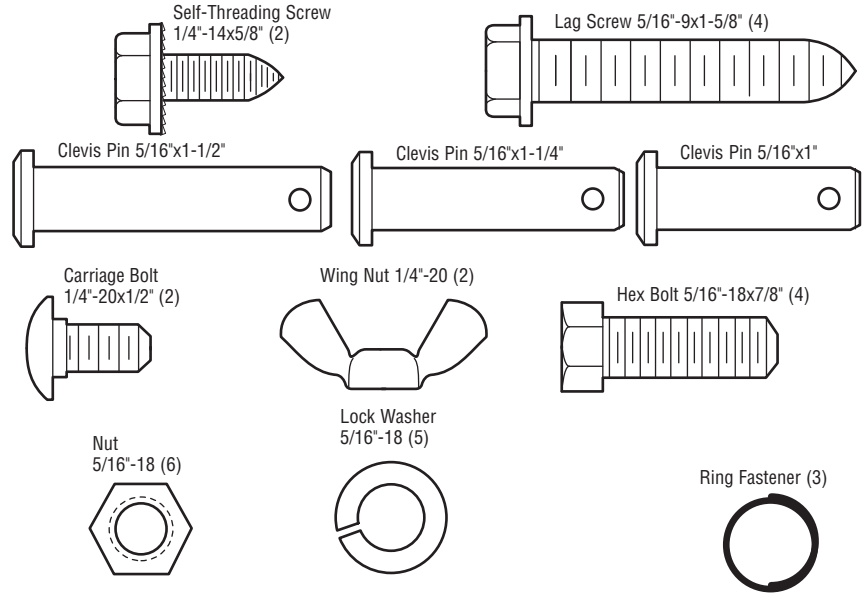

### DOOR CONTROL HARDWARE

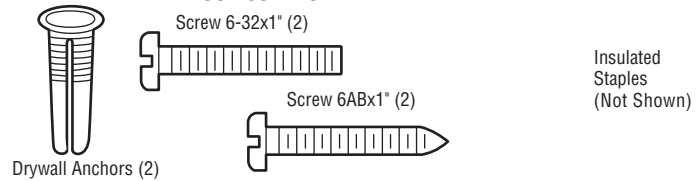

# Assembly

## STEP 1 Assemble the rail and trolley

### CAUTION

To prevent INJURY from pinching, keep hands and fingers away from the joints while assembling the rail.

To avoid installation difficulties, do not run the garage door opener until instructed to do so.

The front rail has a cut out "window" at the door end (see illustration). The hole above this window is larger on the top of the rail than on the bottom. A smaller hole 3-1/2" (8.9 cm) away is close to the rail edge. Rotate the back rail so it has a similar hole close to the opposite edge, about 4-3/4" (12 cm) from the far end.

1. Remove the straight door arm and hanging bracket packaged inside the front rail and set aside for Installation Step 5 and 9. **NOTE:** To prevent INJURY while unpacking the rail carefully remove the straight door arm stored within the rail section.
2. Align the rail sections on a flat surface as shown and slide the tapered ends into the larger ones. Tabs along the side will lock into place.
3. Place the motor unit on packing material to protect the cover, and rest the back end of the rail on top. For convenience, put a support under the front end of the rail.
4. As a temporary stop, insert a screwdriver into the hole 10" (25 cm) from the front end of the rail, as shown.
5. Check to be sure there are 4 plastic wear pads inside the inner trolley. If they became loose during shipping, check all packing material. Snap them back into position as shown.
6. Slide the trolley assembly toward the screwdriver as shown.
7. Slide the rail onto the "U" bracket, until it reaches all the stops on the top and sides of the "U" bracket.

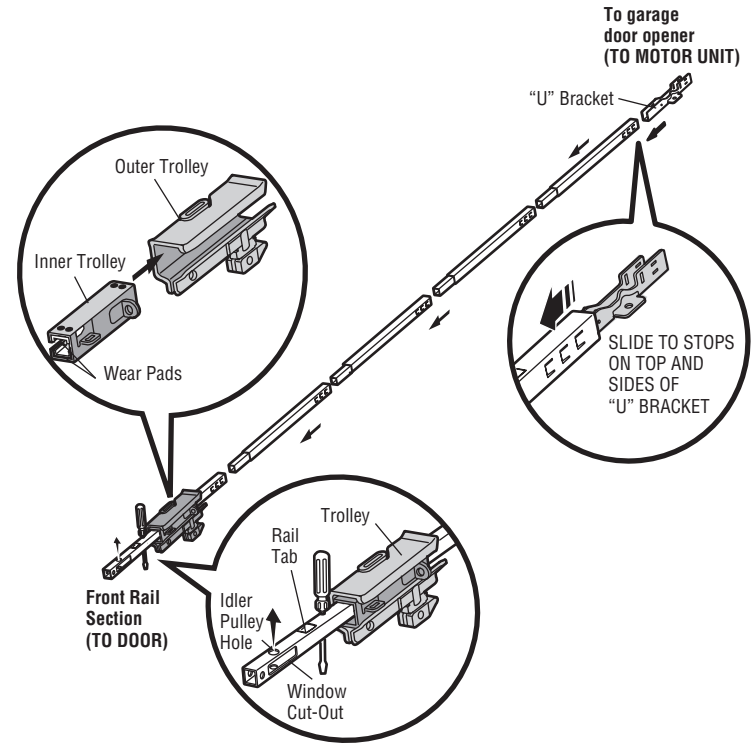

# Assembly

## STEP 2 Fasten the rail to the motor unit

### CAUTION

To avoid **SERIOUS** damage to garage door opener, use **ONLY** those bolts/fasteners mounted in the top of the opener.

### CAUTION

To avoid possible **SERIOUS INJURY** to fingers:

- Securely attach chain spreader.
- **NEVER** connect garage door opener to power source until instructed to do so.

1. Insert a 1/4"-20x1-3/4" bolt into the cover protection bolt hole on the back end of the rail as shown. Tighten securely with a 1/4"-20 lock nut. Do **NOT** overtighten.
2. Remove the two bolts from the top of the motor unit.
3. Use the carton to support the front end of the rail.
4. Place the "U" bracket, flat side down onto the motor unit and align the bracket holes with the bolt holes.
5. Fasten the "U" bracket with the previously removed bolts; **DO NOT** use any power tools. The use of power tools may permanently damage the garage door opener.
6. Attach spreader to the motor unit with two screws.

#### HARDWARE

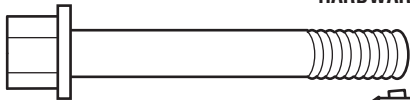

Bolt 1/4"-20x1-3/4"

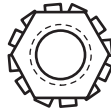

Lock Nut 1/4"-20

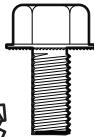

Bolts  
(Mounted in the  
garage door opener)

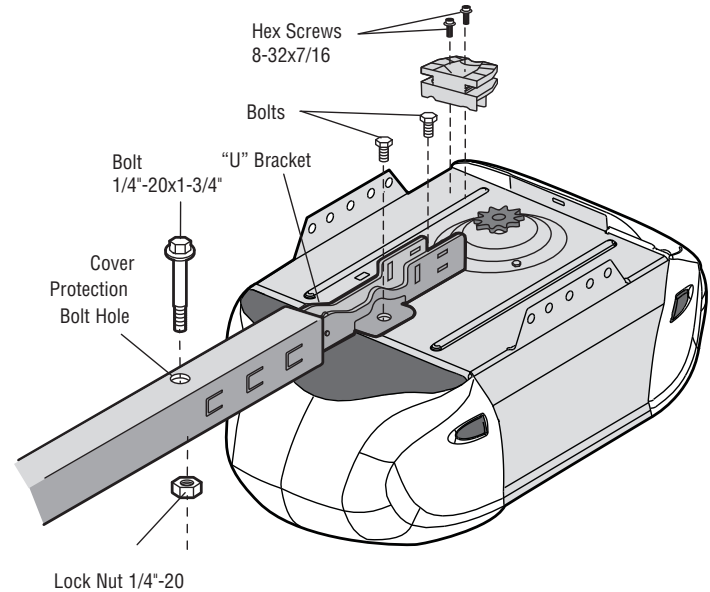

# Assembly

## STEP 3 Install the idler pulley

1. Lay the chain/cable beside the rail, as shown. Grasp the end with the cable loop and pass approximately 12" (30 cm) of cable through the window. Allow it to hang until Assembly Step 4.
2. Remove the tape from the idler pulley. The inside center should be pre-greased. If dry, regrease to ensure proper operation.
3. Place the idler pulley into the window as shown.
4. Insert the idler bolt from the top through the rail and pulley. Tighten with a 3/8" lock washer and nut underneath the rail until the lock washer is compressed.
5. Rotate the pulley to be sure it spins freely.
6. Locate the rail tab. The rail tab is between the idler bolt and the trolley in the front rail section. Use a flat head screwdriver and lift the rail tab until the tab is vertical (90°).

### HARDWARE

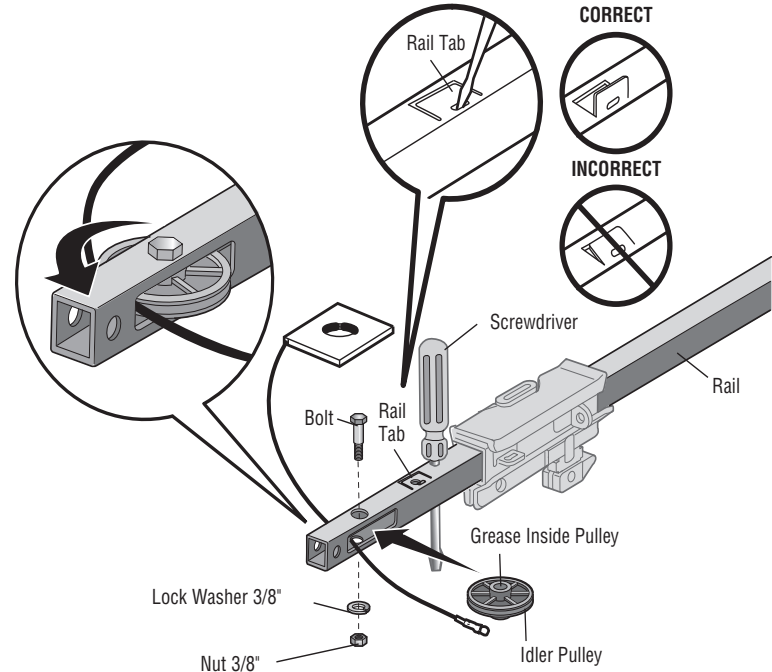
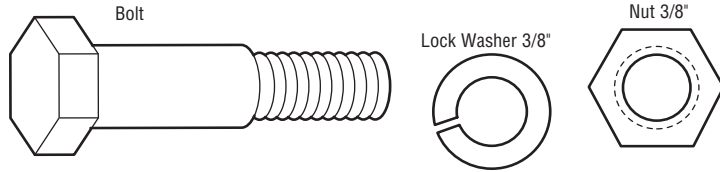



# Assembly

## STEP 4 Install the chain

1. Pull the cable around the idler pulley and toward the trolley.
2. Connect the cable to the retaining slot on the trolley. **(a)**
  - a. Push pins of master link bar through cable link and trolley slot.
  - b. Push master link cap over pins and past pin notches.
  - c. Slide clip-on spring over cap and onto pin notches until both pins are securely locked in place.
3. With the trolley against the screwdriver, dispense the remainder of the cable/chain along the rail toward the motor unit into the slot on the chain spreader, around the sprocket onto the chain spreader and continuing to the trolley assembly. The sprocket teeth must engage the chain. **(b)**
4. Check to make sure the chain is not twisted, then connect it to the threaded shaft with the remaining master link.
5. Thread the inner nut and lock washer onto the trolley threaded shaft.
6. Insert the trolley threaded shaft through the hole in the trolley. Be sure the chain is not twisted. **(c)**
7. Loosely thread the outer nut onto the trolley threaded shaft.
8. Remove the screwdriver.

### HARDWARE

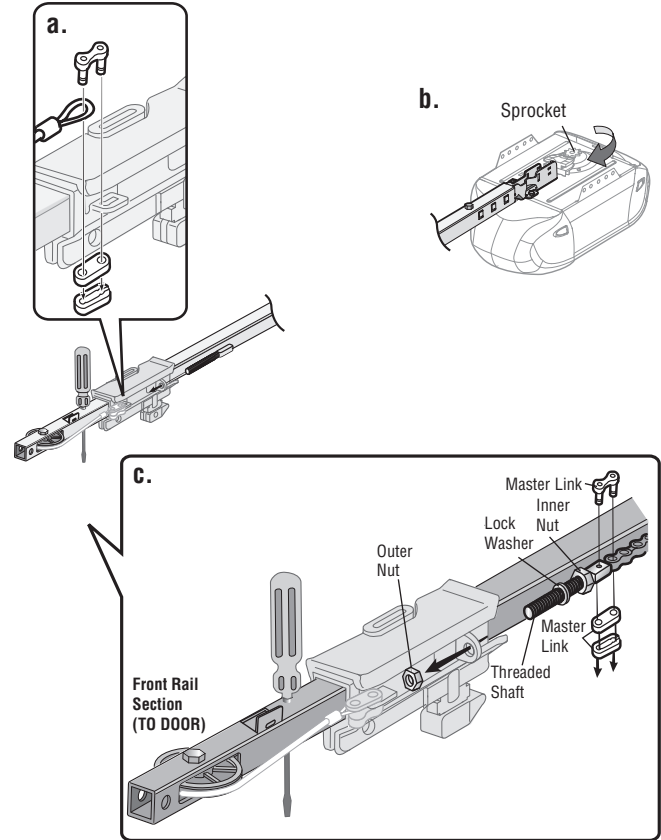
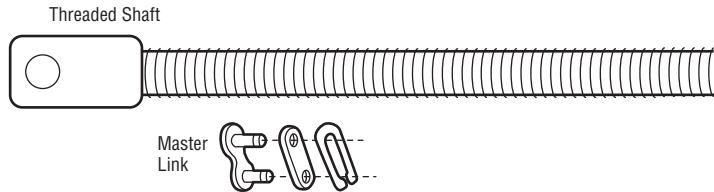

# Assembly

## STEP 5 Tighten the chain

1. Spin the inner nut and lock washer down the trolley threaded shaft, away from the trolley.
2. To tighten the chain, turn the outer nut in the direction shown.
3. When the chain is approximately 1/4" (6 mm) above the base of the rail at its midpoint, re-tighten the inner nut to secure the adjustment.

Sprocket noise can result if the chain is too loose. When installation is complete, you may notice some chain droop with the door closed. This is normal. If the chain returns to the position shown when the door is open, do not re-adjust the chain.

### NOTES:

- During future maintenance, ALWAYS pull the emergency release handle to disconnect the trolley before adjusting the chain.
- You may notice loosening of the chain after Adjustment Step 3 (Test the Safety Reversal System). Check for proper tension and readjust chain if necessary. Then repeat Adjustment Step 3.

**You have now finished assembling your garage door opener. Please read the following warnings before proceeding to the installation section.**

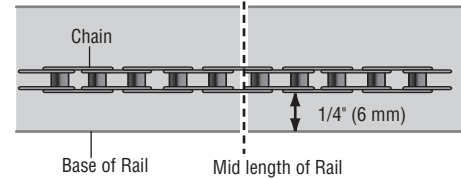
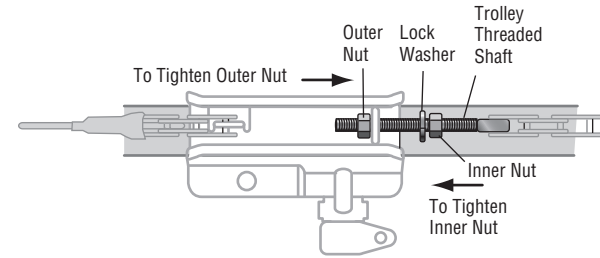

## IMPORTANT INSTALLATION INSTRUCTIONS



### To reduce the risk of SEVERE INJURY or DEATH:

1. READ AND FOLLOW ALL INSTALLATION WARNINGS AND INSTRUCTIONS.
2. Install garage door opener ONLY on properly balanced and lubricated garage door. An improperly balanced door may NOT reverse when required and could result in SEVERE INJURY or DEATH.
3. ALL repairs to cables, spring assemblies and other hardware MUST be made by a trained door systems technician BEFORE installing opener.
4. Disable ALL locks and remove ALL ropes connected to garage door BEFORE installing opener to avoid entanglement.
5. Install garage door opener 7 feet (2.13 m) or more above floor.
6. Mount the emergency release within reach, but at least 6 feet (1.83 m) above the floor and avoiding contact with vehicles to avoid accidental release.
7. NEVER connect garage door opener to power source until instructed to do so.
8. NEVER wear watches, rings or loose clothing while installing or servicing opener. They could be caught in garage door or opener mechanisms.
9. Install wall-mounted garage door control:
  - within sight of the garage door.
  - out of reach of children at minimum height of 5 feet (1.5 m).
  - away from ALL moving parts of the door.
10. Place entrapment warning label on wall next to garage door control.
11. Place manual release/safety reverse test label in plain view on inside of garage door.
12. Upon completion of installation, test safety reversal system. Door MUST reverse on contact with a 1-1/2" (3.8 cm) high object (or a 2x4 laid flat) on the floor.
13. To avoid SERIOUS PERSONAL INJURY or DEATH from electrocution, disconnect ALL electric power BEFORE performing any service or maintenance.

# Installation

## STEP 1 Determine the header bracket location

### **WARNING**

To prevent possible **SERIOUS INJURY** or **DEATH**:

- Header bracket **MUST** be **RIGIDLY** fastened to structural support on header wall or ceiling, otherwise garage door might **NOT** reverse when required. **DO NOT** install header bracket over drywall.
- Concrete anchors **MUST** be used if mounting header bracket or 2x4 into masonry.
- **NEVER** try to loosen, move or adjust garage door, springs, cables, pulleys, brackets, or their hardware, **ALL** of which are under **EXTREME** tension.
- **ALWAYS** call a trained door systems technician if garage door binds, sticks, or is out of balance. An unbalanced garage door might **NOT** reverse when required.

Installation procedures vary according to garage door types. Follow the instructions which apply to your door.

1. Close the door and mark the inside vertical centerline of the garage door.
2. Extend the line onto the header wall above the door.

**You can fasten the header bracket within 4 feet (1.22 m) of the left or right of the door center only if a torsion spring or center bearing plate is in the way; or you can attach it to the ceiling when clearance is minimal. (It may be mounted on the wall upside down if necessary, to gain approximately 1/2" (1 cm).**

If you need to install the header bracket on a 2x4 (on wall or ceiling), use lag screws (not provided) to securely fasten the 2x4 to structural supports.

3. Open your door to the highest point of travel as shown. Draw an intersecting horizontal line on the header wall 2" (5 cm) above the high point:
  - 2" (5 cm) above the high point for sectional door and one-piece door with track.
  - 8" (20 cm) above the high point for one-piece door without track.

This height will provide travel clearance for the top edge of the door. **NOTE:** If the total number of inches exceeds the height available in your garage, use the maximum height possible, or refer to page 12 for ceiling installation.

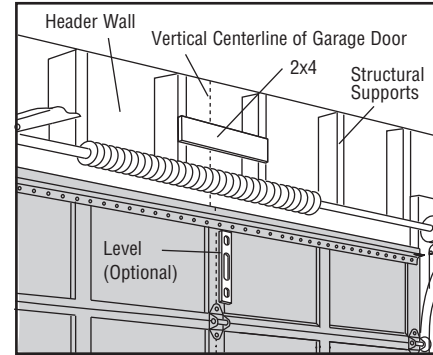

### OPTIONAL CEILING MOUNT FOR HEADER BRACKET

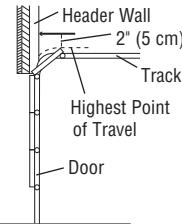
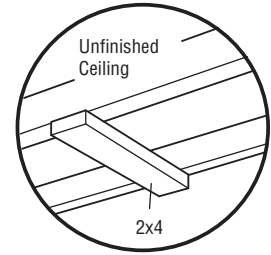

Sectional door with curved track

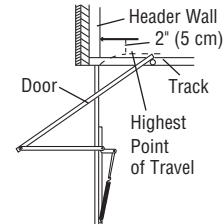

One-piece door with horizontal track

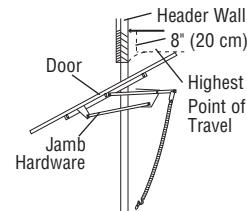

One-piece door without track:  
jamb hardware

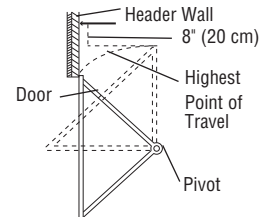

One-piece door without track:  
pivot hardware

# Installation

## STEP 2 Install the header bracket

You can attach the header bracket either to the wall above the garage door, or to the ceiling. Follow the instructions which will work best for your particular requirements. **Do not install the header bracket over drywall. If installing into masonry, use concrete anchors (not provided).**

### HARDWARE

Lag Screw 5/16"-9x1-5/8"

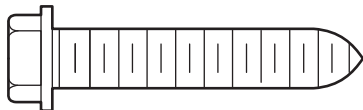

## OPTION A WALL INSTALLATION

1. Center the bracket on the vertical centerline with the bottom edge of the bracket on the horizontal line as shown.
2. Mark the vertical set of bracket holes. Drill 3/16" pilot holes and fasten the bracket securely to a structural support with the hardware provided.

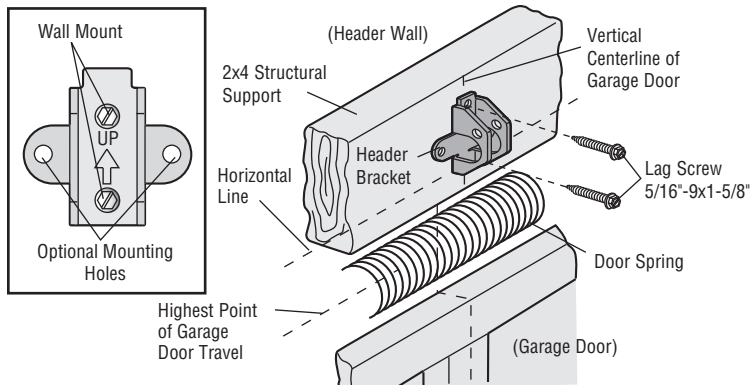

## OPTION B CEILING INSTALLATION

1. Extend the vertical centerline onto the ceiling as shown.
2. Center the bracket on the vertical mark, no more than 6" (15 cm) from the wall. Make sure the arrow is pointing away from the wall. The bracket can be mounted flush against the ceiling when clearance is minimal.
3. Mark the side holes. Drill 3/16" pilot holes and fasten bracket securely to a structural support with the hardware provided.

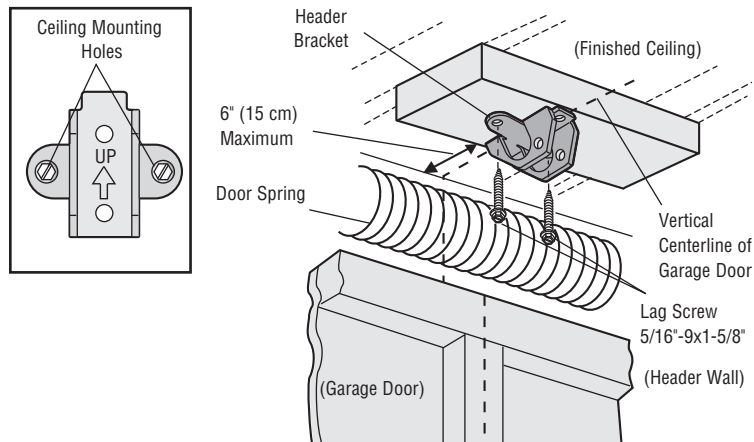

# Installation

## STEP 3 Attach the rail to the header bracket

1. Align the rail with the header bracket. Insert the clevis pin through the holes in the header bracket and rail. Secure with the ring fastener.

**NOTE:** Use the packing material as a protective base for the garage door opener.

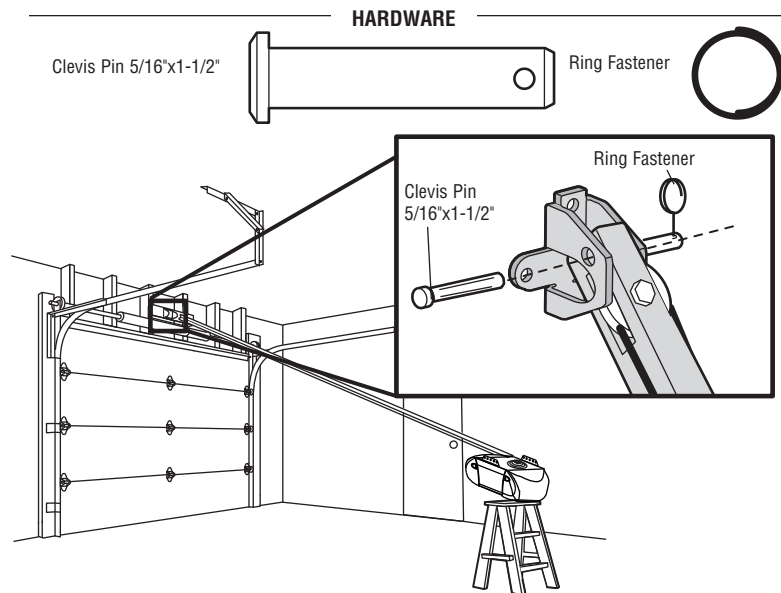

## STEP 4 Position the garage door opener

### CAUTION

To prevent damage to garage door, rest garage door opener rail on 2x4 placed on top section of door.

1. Remove the packing material and lift the garage door opener onto a ladder.
2. Fully open the door and place a 2x4 (laid flat) under the rail. For one-piece doors without tracks, lay the 2x4 on it's side.

**NOTE:** A 2x4 is ideal for setting the distance between the rail and the door. If the ladder is not tall enough you will need help at this point. If the door hits the trolley when it is raised, pull the trolley release arm down to disconnect the inner and outer trolley. Slide the outer trolley toward the garage door opener. The trolley can remain disconnected until instructed.

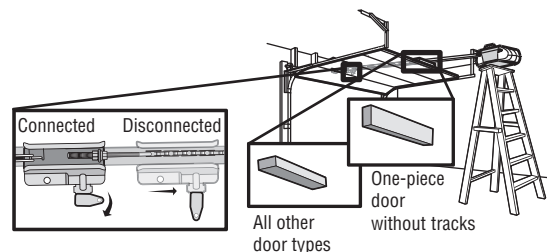

# Installation

## STEP 5 Hang the garage door opener

### **WARNING**

To avoid possible **SERIOUS INJURY** from a falling garage door opener, fasten it **SECURELY** to structural supports of the garage. Concrete anchors **MUST** be used if installing **ANY** brackets into masonry.

Hanging the garage door opener will vary depending on your garage. Below are three example installations. Your installation may be different. For **ALL** installations the garage door opener **MUST** be connected to structural supports. The instructions illustrate one of the examples below.

Finished Ceiling

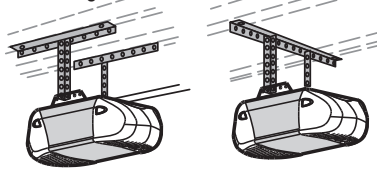

Unfinished Ceiling



### HARDWARE

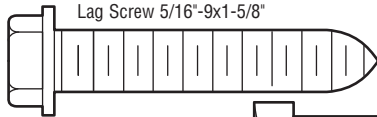

Lag Screw 5/16"-9x1-5/8"

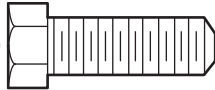

Hex Bolt 5/16"- 18x7/8"

Lock Washer  
5/16"-18



Nut 5/16"-18



1. On finished ceilings, use the lag screws to attach a support bracket (not provided) to the structural supports before installing the garage door opener.
2. Make sure the garage door opener is aligned with the header bracket. Measure the distance from each side of the garage door opener to the support bracket.
3. Cut both pieces of the hanging bracket to required lengths.
4. Attach the end of each hanging bracket to the support bracket with appropriate hardware (not provided).
5. Attach the garage door opener to the hanging brackets with the hex bolts, lock washers, and nuts.
6. Remove the 2x4 and manually close the door. If the door hits the rail, raise the header bracket.

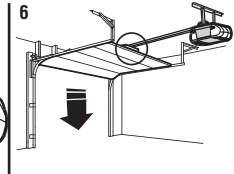
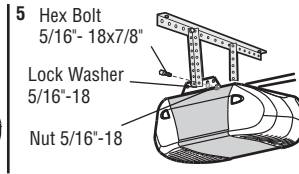
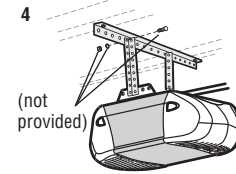
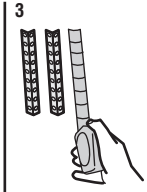
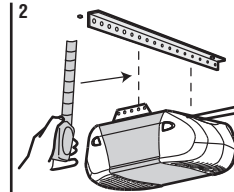
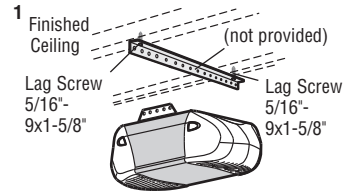

# Installation

## STEP 6 Install the light bulbs

### CAUTION

To prevent possible OVERHEATING of the endpanel or light socket:

- DO NOT use short neck or specialty light bulbs.
- DO NOT use halogen bulbs. Use ONLY incandescent.

To prevent damage to the opener:

- DO NOT use bulbs larger than 100W.
- ONLY use A19 size bulbs.

1. Install a 100 watt maximum light bulb in each socket. Light bulb size should be A19, standard neck only. The lights will turn ON and remain lit for approximately 4-1/2 minutes when power is connected. Then the lights will turn OFF.
2. Insert bottom lens tabs into slots on chassis. Tilt towards chassis to engage top tabs, then drop down gently into place (see illustration).
3. To remove, depress both top lens tabs. Tilt lens slightly outward and down, then pull out to clear bulbs. Use care to avoid snapping off bottom lens tabs.
4. Use A19, standard neck garage door opener bulbs for replacement.

**NOTE:** Use only standard light bulbs. The use of short neck or specialty light bulbs may overheat the endpanel or light socket.

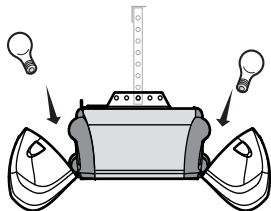

## STEP 7 Attach the emergency release rope and handle

### ! WARNING

To prevent possible SERIOUS INJURY or DEATH from a falling garage door:

- If possible, use emergency release handle to disengage trolley ONLY when garage door is CLOSED. Weak or broken springs or unbalanced door could result in an open door falling rapidly and/or unexpectedly.
- NEVER use emergency release handle unless garage doorway is clear of persons and obstructions.
- NEVER use handle to pull door open or closed. If rope knot becomes untied, you could fall.

1. Insert one end of the emergency release rope through the handle. Make sure that "NOTICE" is right side up. Tie a knot at least 1 inch (2.5 cm) from the end of the emergency release rope.
2. Insert the other end of the emergency release rope through the hole in the trolley release arm. Mount the emergency release within reach, but at least 6 feet (1.83 m) above floor, avoiding contact with vehicles to prevent accidental release and secure with a knot.

**NOTE:** If it is necessary to cut the emergency release rope, seal the cut end with a match or lighter to prevent unraveling. Ensure the emergency release rope and handle are above the top of all vehicles to avoid entanglement.

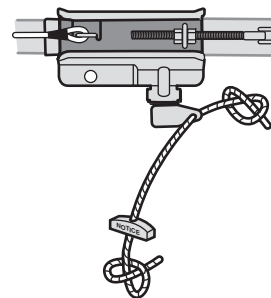



# Installation

## STEP 8 Install the door bracket

### CAUTION

Fiberglass, aluminum or lightweight steel garage doors **WILL REQUIRE** reinforcement BEFORE installation of door bracket. Contact your door manufacturer for reinforcement kit.

Figure 1 shows one piece of angle iron as the horizontal brace. For the vertical brace, 2 pieces of angle iron are used to create a U-shaped support. The best solution is to check with your garage door manufacturer for an opener installation door reinforcement kit.

**NOTE:** Many door reinforcement kits provide for direct attachment of the clevis pin and door arm. In this case you will not need the door bracket; proceed to the next step.

A horizontal and vertical reinforcement is needed for lightweight garage doors (fiberglass, aluminum, steel, doors with glass panel, etc.) (not provided).

A horizontal reinforcement brace should be long enough to be secured to two or three vertical supports. A vertical reinforcement brace should cover the height of the top panel.

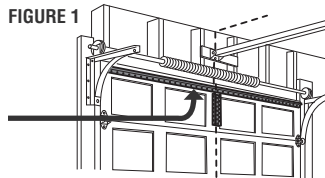

#### HARDWARE

Self-Threading Screw  
1/4"-14x5/8"

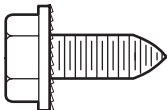

### OPTION A SECTIONAL DOORS

1. Center the door bracket on the previously marked vertical centerline used for the header bracket installation. Note correct UP placement, as stamped inside the bracket.
2. Position the top edge of the bracket 2"-4" (5-10 cm) below the top edge of the door, OR directly below any structural support across the top of the door.
3. Mark, drill holes and install as follows, depending on your door's construction:

**Metal or light weight doors using a vertical angle iron brace between the door panel support and the door bracket:**

- Drill 3/16" fastening holes. Secure the door bracket using the two self threading screws. (Figure 2)
- Alternately, use two 5/16" bolts, lock washers and nuts (not provided). (Figure 3)

**Metal, insulated or light weight factory reinforced doors:**

- Drill 3/16" fastening holes. Secure the door bracket using the self-threading screws. (Figure 4)

**Wood Doors:**

- Use top and bottom or side to side door bracket holes. Drill 5/16" holes through the door and secure bracket with 5/16"x2" carriage bolts, lock washers and nuts (not provided). (Figure 5)

**NOTE:** The 1/4"-14x5/8" self-threading screws are not intended for use on wood doors.

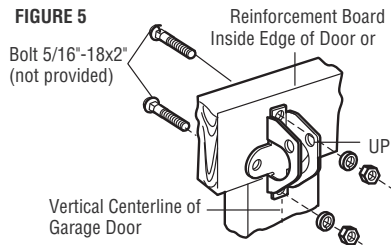
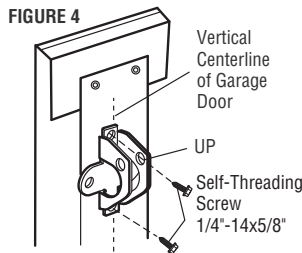
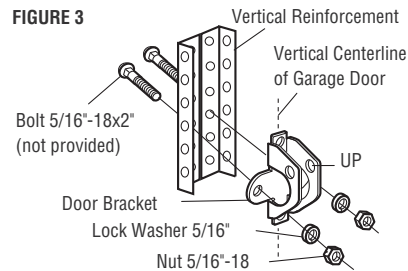
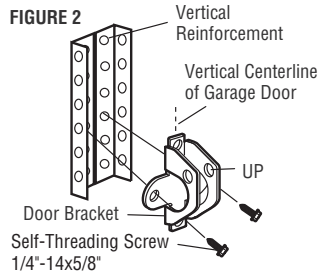

# Installation

## STEP 8 Install the door bracket (continued)

### OPTION B ONE-PIECE DOORS

1. Center the door bracket on the top of the door, in line with the header bracket as shown.
2. Mark either the left and right, or the top and bottom holes.

#### Metal Doors:

- Drill 3/16" pilot holes and fasten the bracket with the self-threading screws provided.

#### Wood Doors:

- Drill 5/16" holes and use 5/16"x2" carriage bolts, lock washers and nuts (not provided) or 5/16"x1-1/2" lag screws (not provided) depending on your installation needs.

**NOTE:** The door bracket may be installed on the top edge of the door if required for your installation. (Refer to the dotted line optional placement drawing.)

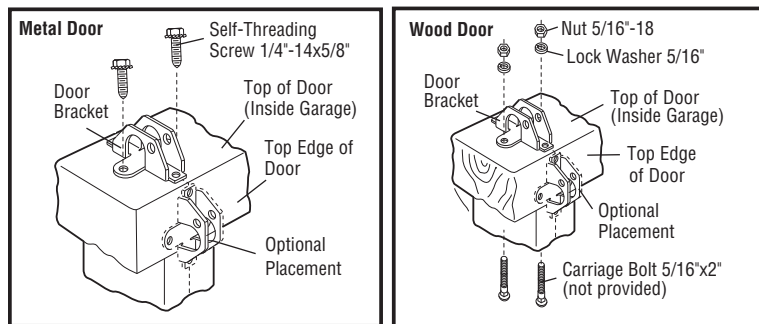
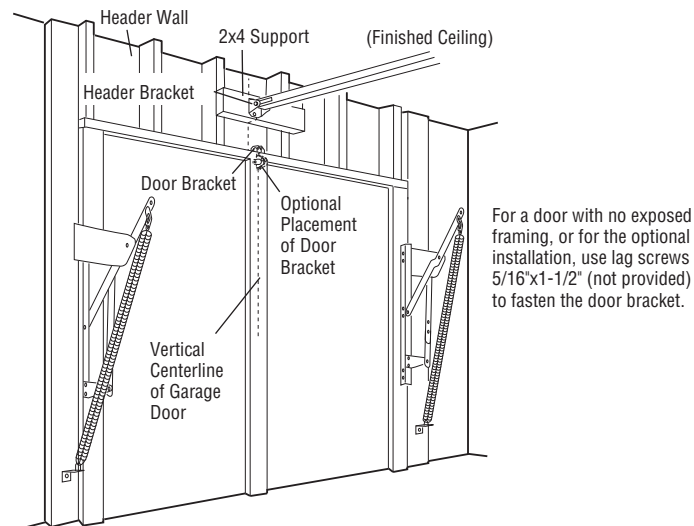

# Installation

## STEP 9 Connect the door arm to the trolley

Installation will vary according to the garage door type. Follow the instructions which apply to your door.

### OPTION A SECTIONAL DOORS

**IMPORTANT:** The groove on the straight door arm **MUST** face away from the curved door arm.

1. Close the door. Disconnect the trolley by pulling the emergency release handle.
2. Attach the straight door arm to the outer trolley using the clevis pin. Secure with the ring fastener.
3. Attach the curved door arm to the door bracket using the clevis pin. Secure with the ring fastener.
4. Bring arm sections together. Find two pairs of holes that line up and join sections. Select holes as far apart as possible to increase door arm rigidity and attach using the bolts, nuts, and lock washers.
5. Pull the emergency release handle toward the garage door opener until the trolley release arm is horizontal. The trolley will re-engage automatically when the garage door opener is activated.

**NOTE:** If the holes in the curved door arm and the straight door arm do not align, reverse the straight door arm, select two holes (as far apart as possible) and attach using bolts, nuts, and lock washers. If the straight door arm is hanging down too far, you may cut 6 inches (15 cm) from the solid end.

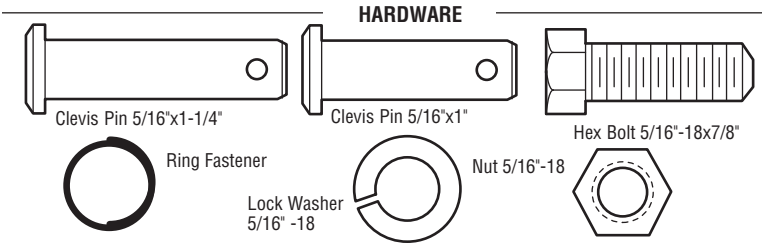
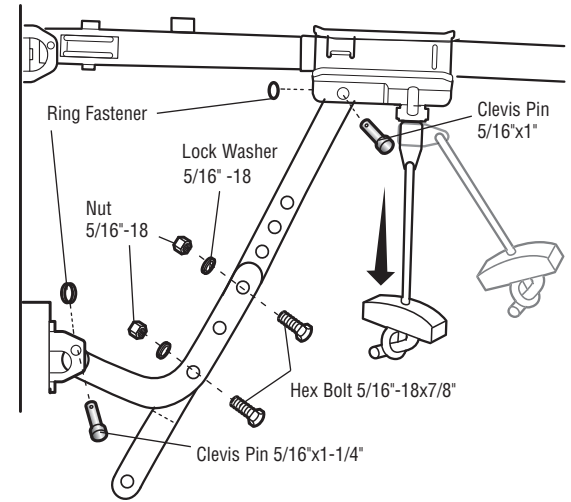
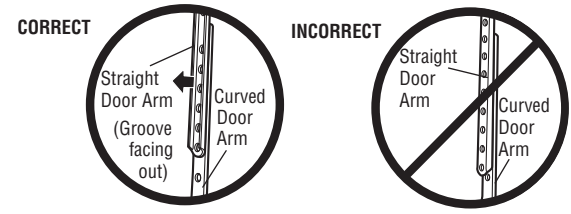

# Installation

## STEP 9 Connect the door arm to the trolley (continued)

### OPTION B ONE-PIECE DOORS

#### 1. Assemble the door arm, Figure 1:

**IMPORTANT:** The groove on the straight door arm **MUST** face away from the curved door arm.

- Fasten the straight and curved door arm sections together to the longest possible length (with a 2 or 3 hole overlap).
- With the door closed, connect the straight door arm section to the door bracket with the 5/16"x1-1/4" clevis pin. Secure with a ring fastener.

#### 2. Adjustment procedures:

- On one-piece doors, before connecting the door arm to the trolley, the travel limits must be adjusted. Limit adjustment screws are located on the left side panel as shown on page 28. Follow adjustment procedures below.
- Open door adjustment : Decrease UP travel limit
  - Turn the UP limit adjustment screw counterclockwise 4 turns.
  - Press the door control push button. The trolley will travel to the fully open position.
  - Manually raise the door to the open position (parallel to the floor), and lift the door arm to the trolley. The arm should touch the trolley just in the back of the door arm connector hole. If the arm does not extend far enough, adjust the limit further. One full turn equals 2" (5 cm) of trolley travel.
- Closed door adjustment : Decrease DOWN travel limit
  - Turn the DOWN limit adjustment screw clockwise 4 complete turns.
  - Press the door control push button. The trolley will travel to the fully closed position.
  - Manually close the door and lift the door arm to the trolley. The arm should touch the trolley just ahead of the door arm connector hole. If the arm is behind the connector hole, adjust the limit further. One full turn equals 2" (5 cm) of trolley travel.

#### 3. Connect the door arm to the trolley:

- Close the door and join the curved arm to the connector hole in the trolley with the remaining clevis pin. It may be necessary to lift the door slightly to make the connection. Secure with a ring fastener.
- Run the opener through a complete travel cycle. If the door has a slight "backward" slant in full open position as shown in the illustration, decrease the UP limit until the door is parallel to the floor (Figure 2).

**NOTE:** A slight backward slant will cause unnecessary bucking and/or jerking operation as the door is being opened or closed from the fully open position. See page 28 for adjustments.

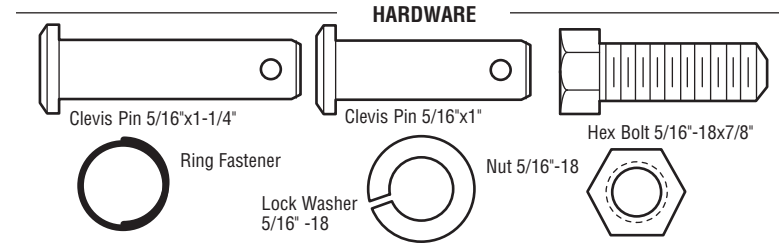

FIGURE 1: Door Closed

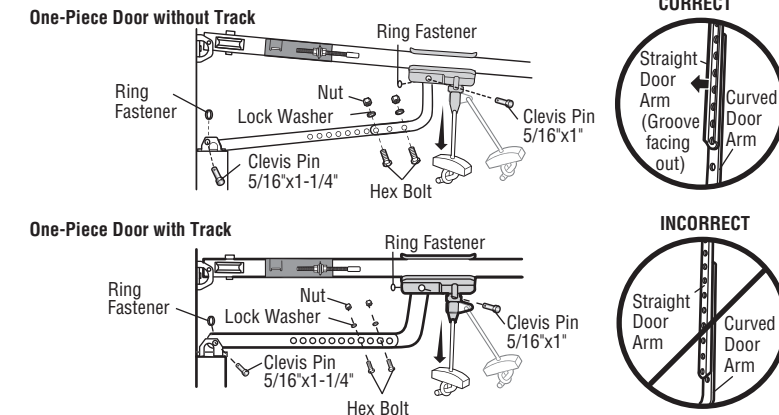
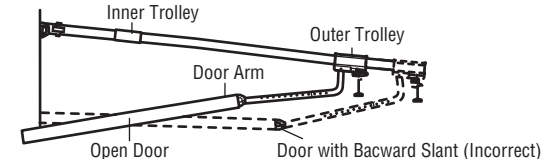

FIGURE 2



# Installation

## STEP 10 Install the door control

### **WARNING**

To prevent possible SERIOUS INJURY or DEATH from electrocution:

- Be sure power is NOT connected BEFORE installing door control.
- Connect ONLY to 24 VOLT low voltage wires.

To prevent possible SERIOUS INJURY or DEATH from a closing garage door:

- Install door control within sight of garage door, out of reach of children at a minimum height of 5 feet (1.5 m), and away from ALL moving parts of door.
- NEVER permit children to operate or play with door control push buttons or remote control transmitters.
- Activate door ONLY when it can be seen clearly, is properly adjusted, and there are no obstructions to door travel.
- ALWAYS keep garage door in sight until completely closed. NEVER permit anyone to cross path of closing garage door.

Install the door control within sight of the door at a minimum height of 5 feet (1.5 m) where small children cannot reach, and away from the moving parts of the door. For gang box installations it is not necessary to drill holes or install the drywall anchors. Use the existing holes in the gang box.

**NOTE:** Your product may look different than the illustrations.

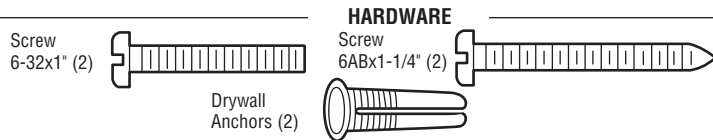

### Connect the door control wires:

1. Strip 7/16" (11 mm) of insulation from one end of bell wire and connect to the two screw terminals on back of door control by color: white wire to WHT (1) and white/red wire to the RED (2). If your garage is pre-wired for the door control, choose any two wires to connect, note which wires are used so the correct wires are connected to the garage door opener in a later step.

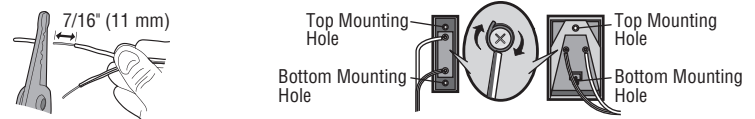

### Install the Multi-Function Door Control:

1. Remove cover by gently prying at the top of the cover with a small flat head screwdriver.
2. Mark the location of the bottom-mounting hole and drill a 5/32 inch (4 mm) hole.
3. Install the bottom screw, allowing 1/8 inch (3 mm) to protrude from the wall.
4. Position the bottom hole of the door control over the screw and slide down into place.
5. Mark and drill the top hole.
6. Attach the top screw.

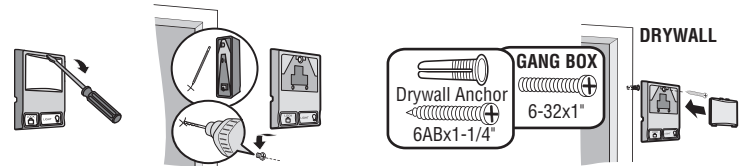

### OR

### Install the Door Control Button:

1. Mark and drill 5/32 inch (4 mm) hole(s).
2. Fasten door control button to wall with screws.

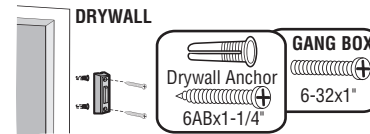

# Installation

## STEP 11 Wire the door control to the garage door opener

### HARDWARE

Insulated Staple  
(Not Shown)

1. Run the white and red/white wire from the door control to the garage door opener. Attach the wire to the wall and ceiling with the staple (not applicable for gang box or pre-wired installations). Do not pierce the wire with the staple as this may cause a short or an open circuit.
2. Strip 7/16 inch (11 mm) of insulation from the end of the wire near the garage door opener.
3. Connect the wire to the red and white terminals on the garage door opener. If your garage is pre-wired make sure you use the same wires that are connected to the door control. To insert or release wires from the terminal, push in the tab with screwdriver tip.

1

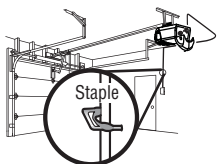

2

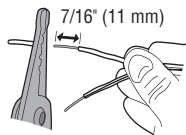

3

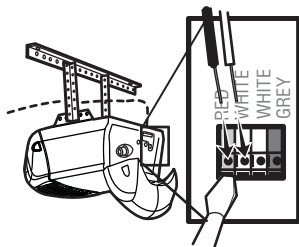

## STEP 12 Attach the warning labels

1. Attach the entrapment warning label on the wall near the door control with tacks or staples.
2. Attach the manual release/safety reverse test label in a visible location on the inside of the garage door.

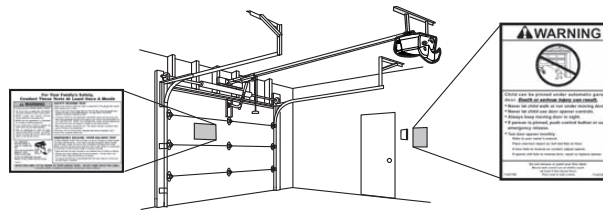

# Installation

## STEP 13 Install the Protector System®

### **WARNING**

Be sure power is NOT connected to the garage door opener BEFORE installing the safety reversing sensor.

To prevent SERIOUS INJURY or DEATH from closing garage door:

- Correctly connect and align the safety reversing sensor. This required safety device MUST NOT be disabled.
- Install the safety reversing sensor so beam is NO HIGHER than 6" (15 cm) above garage floor.

**The safety reversing sensor must be connected and aligned correctly before the garage door opener will move in the down direction.**

#### IMPORTANT INFORMATION ABOUT THE SAFETY REVERSING SENSOR

When properly connected and aligned, the sensor will detect an obstacle in the path of its electronic beam. The sending eye (with an amber indicator light) transmits an invisible light beam to the receiving eye (with a green indicator light). If an obstruction breaks the light beam while the door is closing, the door will stop and reverse to full open position, and the opener lights will flash 10 times.

The units must be installed inside the garage so that the sending and receiving eyes face each other across the door, no more than 6" (15 cm) above the floor. Either can be installed on the left or right of the door as long as the sun never shines directly into the receiving eye lens.

The mounting brackets are designed to clip onto the track of sectional garage doors without additional hardware.

If it is necessary to mount the units on the wall, the brackets must be securely fastened to a solid surface such as the wall framing. Extension brackets (see accessories) are available if needed. If installing in masonry construction, add a piece of wood at each location to avoid drilling extra holes in masonry if repositioning is necessary.

The invisible light beam path must be unobstructed. No part of the garage door (or door tracks, springs, hinges, rollers or other hardware) may interrupt the beam while the door is closing.

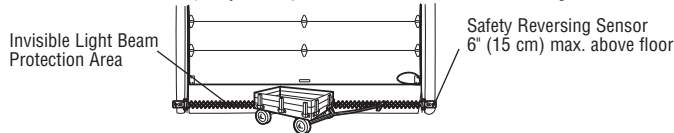

Facing the door from inside the garage

### HARDWARE

Carriage Bolt  
1/4"-20x1/2"

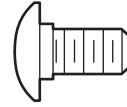

Wing Nut  
1/4"-20



The safety reversing sensors can be attached to the door track, the wall, or the floor. The sensors should be no more than 6 inches (15 cm) above the floor. If the door track will not support the sensor bracket a wall installation is recommended. Choose one of the following installations.

### OPTION A DOOR TRACK INSTALLATION

1. Slide the curved arms of the sensor bracket around the edge of the door track. Snap into place so that the sensor bracket is flush against the track.
2. Slide the carriage bolt into the slot on each sensor.
3. Insert the bolt through the hole in the sensor bracket and attach with the wing nut. The lenses on both sensors should point toward each other. Make sure the lens is not obstructed by the sensor bracket.

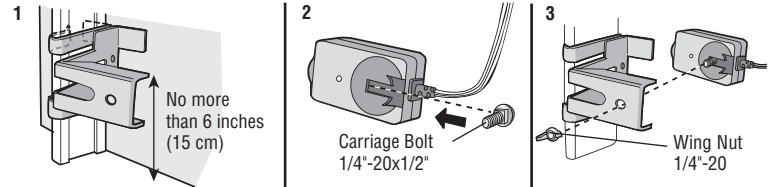

# Installation

## STEP 13 Install the Protector System® (continued)

### OPTION B WALL INSTALLATION

If additional clearance is needed an extension bracket (not provided) or wood blocks can be used. Make sure each bracket has the same amount of clearance so they will align correctly.

1. Position the sensor bracket against the wall with the curved arms facing the door. Make sure there is enough clearance for the beam to be unobstructed. Mark holes.
2. Drill 3/16 inch pilot holes for each sensor bracket and attach the sensor brackets to the wall using lag screws (not provided).
3. Slide the carriage bolt into the slot on each sensor.
4. Insert the bolt through the hole in the sensor bracket and attach with the wing nut. The lenses on both sensors should point toward each other. Make sure the lens is not obstructed by the sensor bracket.

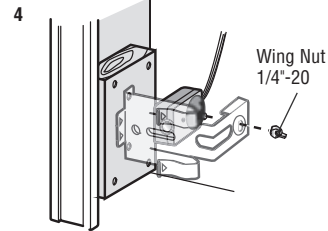
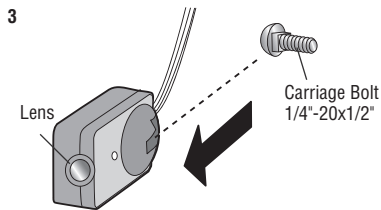
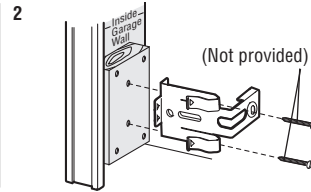
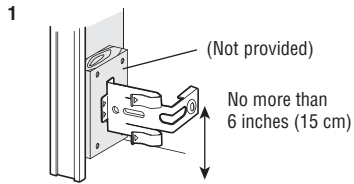

### OPTION C FLOOR INSTALLATION

Use an extension bracket (not provided) or wood block to raise the sensor bracket if needed.

1. Carefully measure the position of both sensor brackets so they will be the same distance from the wall and unobstructed.
2. Attach the sensor brackets to the floor using concrete anchors (not provided).
3. Slide the carriage bolt into the slot on each sensor.
4. Insert the bolt through the hole in the sensor bracket and attach with the wing nut. The lenses on both sensors should point toward each other. Make sure the lens is not obstructed by the sensor bracket.

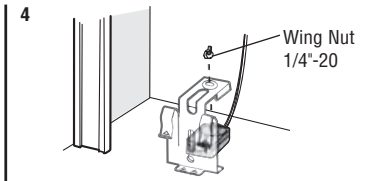
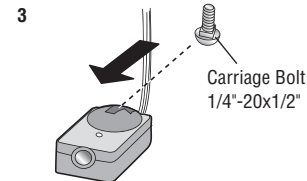
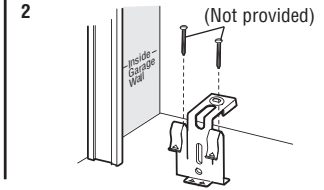
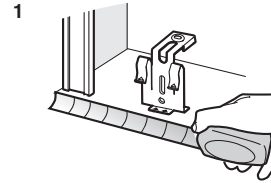



# Installation

## STEP 14 Wire the Safety Reversing Sensors

If your garage already has wires installed for the safety reversing sensors, proceed to page 25.

### HARDWARE

Insulated Staple  
(Not Shown)

### OPTION A INSTALLATION WITHOUT PRE-WIRING

1. Run the wire from both sensors to the garage door opener. Attach the wire to the wall and ceiling with the staples.
2. Strip 7/16 inch (11 mm) of insulation from each set of wires. Separate the wires. Twist the white wires together. Twist the white/black wires together.
3. Insert the white wires into the white terminal on the garage door opener. Insert the white/black wires into the grey terminal on the garage door opener. To insert or remove the wires from the terminal, push in the tab with a screwdriver tip.

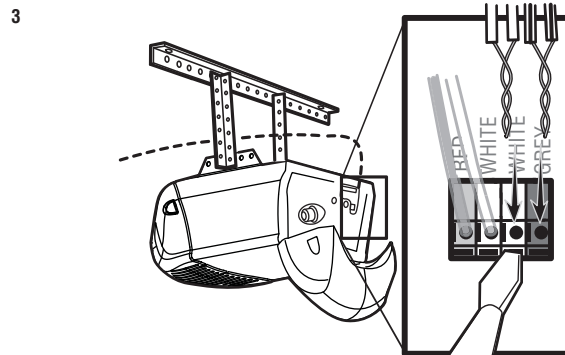
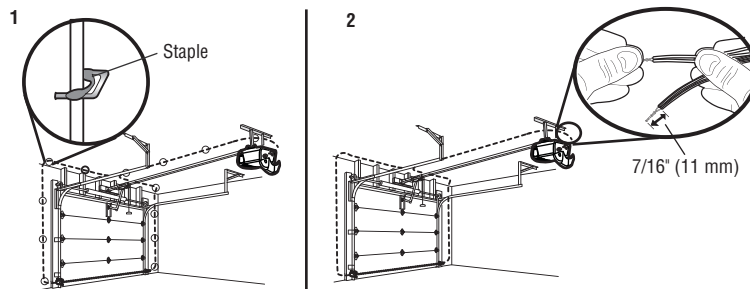

# Installation

## STEP 14 Wire the Safety Reversing Sensors (continued)

### OPTION B PRE-WIRED INSTALLATION

1. Cut the end of the safety reversing sensor wire, making sure there is enough wire to reach the pre-installed wires from the wall.
2. Separate the safety reversing sensor wires and strip 7/16 inch (11 mm) of insulation from each end. Choose two of the pre-installed wires and strip 7/16 inch (11 mm) of insulation from each end. Make sure that you choose the same color pre-installed wires for each sensor.
3. Connect the pre-installed wires to the sensor wires with wire nuts making sure the colors correspond for each sensor. For example, the white wire would connect to the yellow wire and the white/black wire would connect to the purple wire.
4. At the garage door opener, strip 7/16 inch (11 mm) of insulation from each end of the wires previously chosen for the safety reversing sensors. Twist the like-colored wires together.
5. Insert the wires connected to the white safety sensor wires to the white terminal on the garage door opener. Insert the wires that are connected to the white/black safety sensor wires to the purple terminal on the garage door opener.

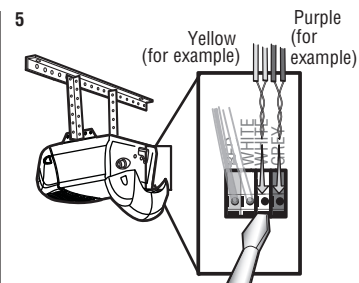
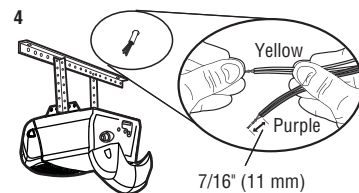
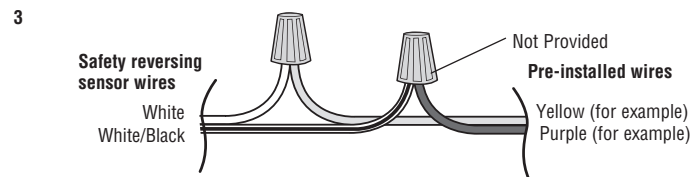
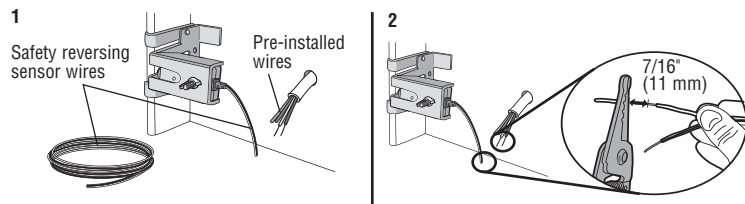

To insert or remove the wires from the terminal, push in the tab with a screwdriver tip.

# Installation

## STEP 15 Connect power

### **WARNING**

To prevent possible **SERIOUS INJURY** or **DEATH** from electrocution or fire:

- Be sure power is **NOT** connected to the opener, and disconnect power to circuit **BEFORE** removing cover to establish permanent wiring connection.
- Garage door installation and wiring **MUST** be in compliance with **ALL** local electrical and building codes.
- **NEVER** use an extension cord, 2-wire adapter, or change plug in any way to make it fit outlet. Be sure the opener is grounded.

**To avoid installation difficulties, do not activate the garage door opener at this time.**

To reduce the risk of electric shock, your garage door opener has a grounding type plug with a third grounding pin. This plug will only fit into a grounding type outlet. If the plug doesn't fit into your outlet, contact a qualified electrician to install the proper outlet.

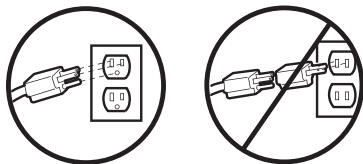

**THERE ARE TWO OPTIONS FOR CONNECTING POWER:**

### **OPTION A** TYPICAL WIRING

1. Plug in the garage door opener into a grounded outlet.
2. **DO NOT** run garage door opener at this time.

### **OPTION B** PERMANENT WIRING

**If permanent wiring is required by your local code, refer to the following procedure. To make a permanent connection through the 7/8 inch hole in the top of the motor unit (according to local code):**

1. Remove the motor unit cover screws and set the cover aside.
2. Remove the attached 3-prong cord.
3. Connect the black (line) wire to the screw on the brass terminal; the white (neutral) wire to the screw on the silver terminal; and the ground wire to the green ground screw. **The opener must be grounded.**
4. Reinstall the cover.

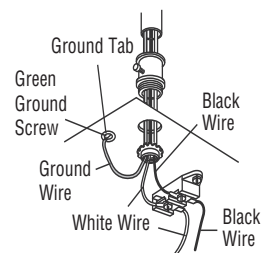

# Installation

## STEP 16 Ensure the safety reversing sensors are aligned

The door will not close if the sensors have not been installed and aligned correctly.

When the light beam is obstructed or misaligned while the door is closing, the door will reverse and the garage door opener lights will flash ten times. If the door is already open, it will not close. The sensors can be aligned by loosening the wing nuts, aligning the sensors, and tightening the wing nuts.

Check to make sure the LEDs in both sensors are glowing steadily. The LEDs in both sensors will glow steadily if they are aligned and wired correctly.

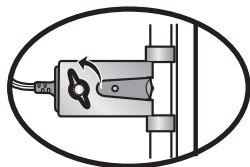

If the receiving sensor is in direct sunlight, switch it with sending sensor so it is on the opposite side of the door.

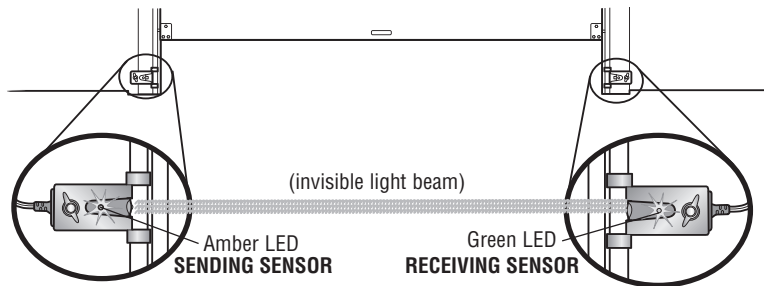

### IF THE AMBER LED ON THE SENDING SENSOR IS NOT GLOWING:

1. Make sure there is power to the garage door opener.
2. Make sure the sensor wire is not shorted/broken.
3. Make sure the sensor has been wired correctly: white wires to white terminal and white/black wires to grey terminal.

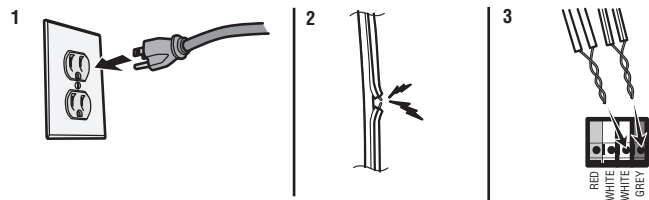

### IF THE GREEN LED ON THE RECEIVING SENSOR IS NOT GLOWING:

1. Make sure the sensor wire is not shorted/broken.
2. Make sure the sensors are aligned.

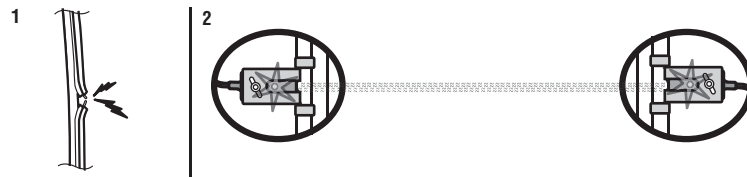

# Adjustments

## Step 1 Adjust the UP and DOWN Travel Limits

### WARNING

Without a properly installed safety reversal system, persons (particularly small children) could be SERIOUSLY INJURED or KILLED by a closing garage door.

- Incorrect adjustment of garage door travel limits will interfere with proper operation of safety reversal system.
- After ANY adjustments are made, the safety reversal system MUST be tested. Door MUST reverse on contact with 1-1/2" (3.8 cm) high object (or 2x4 laid flat) on floor.

### CAUTION

To prevent damage to vehicles, be sure fully open door provides adequate clearance.

Limit adjustment settings regulate the points at which the door will stop when moving up or down.

To operate the opener, press the Door Control push bar.

**Run the opener through a complete travel cycle.**

- Does the door open and close completely?
- Does the door stay closed and not reverse unintentionally when fully closed?

If your door passes both of these tests, no limit adjustments are necessary unless the reversing test fails (Adjustment Step 3, page 30).

Adjustment procedures are outlined below. Read the procedures carefully before proceeding to Adjustment Step 2. Use a screwdriver to make limit adjustments.

Run the opener through a complete travel cycle after each adjustment.

**NOTE:** Repeated operation of the opener during adjustment procedures may cause the motor to overheat and shut off. Simply wait 15 minutes and try again.

**NOTE:** Anything interferes with the door's upward travel, it will stop. If anything interferes with the door's downward travel (including binding or unbalanced doors), it will reverse.

## HOW AND WHEN TO ADJUST THE LIMITS

- **If the door does not open completely but opens at least five feet (1.5 m):**

Increase up travel. Turn the UP limit adjustment screw clockwise. One turn equals 2" (5 cm) of travel.

**NOTE:** To prevent the trolley from hitting the cover protection bolt, keep a minimum distance of 2-4" (5 cm - 10 cm) between the trolley and the bolt.

- **If door does not open at least 5 feet (1.5 m):**

Adjust the UP (open) force as explained in Adjustment Step 2.

- **If the door does not close completely:**

Increase down travel. Turn the DOWN limit adjustment screw counterclockwise. One turn equals 2" (5 cm) of travel.

If door still won't close completely and the trolley bumps into the pulley bracket, try lengthening the door arm (page 18) and decreasing the down limit.

- **If the opener reverses in fully closed position:**

Decrease down travel. Turn the DOWN limit adjustment screw clockwise. One turn equals 2" (5 cm) of travel.

- **If the door reverses when closing and there is no visible interference to travel cycle:**

If the opener lights are flashing, the Safety Reversing Sensors are either not installed, misaligned, or obstructed. See page 27.

Test the door for binding: Pull the emergency release handle. Manually open and close the door. If the door is binding or unbalanced, call for a trained door systems technician. If the door is balanced and not binding, adjust the DOWN (close) force. See Adjustment Step 2.

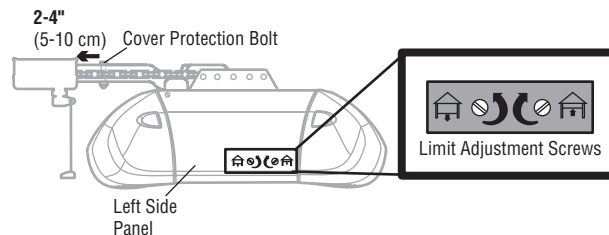

# Adjustments

## Step 2 Adjust the Force

### **WARNING**

Without a properly installed safety reversal system, persons (particularly small children) could be **SERIOUSLY INJURED** or **KILLED** by a closing garage door.

- Too much force on garage door will interfere with proper operation of safety reversal system.
- NEVER increase force beyond minimum amount required to close garage door.
- NEVER use force adjustments to compensate for a binding or sticking garage door.
- If one control (force or travel limits) is adjusted, the other control may also need adjustment.
- After ANY adjustments are made, the safety reversal system **MUST** be tested. Door **MUST** reverse on contact with 1-1/2" high (3.8 cm) object (or 2x4 laid flat) on floor.

Force adjustment controls are located on the back panel of the motor unit. Force adjustment settings regulate the amount of power required to open and close the door.

If the forces are set too light, door travel may be interrupted by nuisance reversals in the down direction and stops in the up direction. Weather conditions can affect the door movement, so occasional adjustment may be needed.

**The maximum force adjustment range is about 3/4 of a complete turn. Do not force controls beyond that point.**

Turn force adjustment controls with a screwdriver.

**NOTE:** *If anything interferes with the door's upward travel, it will stop. If anything interferes with the door's downward travel (including binding or unbalanced doors), it will reverse.*

## HOW AND WHEN TO ADJUST THE FORCES

### 1. Test the **DOWN (close) force**

- Grasp the door bottom when the door is about halfway through DOWN (close) travel. The door should reverse. Reversal halfway through down travel does not guarantee reversal on a 1-1/2" (3.8 cm) obstruction. See Adjustment Step 3, page 30. **If the door is hard to hold or doesn't reverse, DECREASE** the DOWN (close) force by turning the control counterclockwise. Make small adjustments until the door reverses normally. After each adjustment, run the opener through a complete cycle.
- **If the door reverses during the down (close) cycle and the opener lights aren't flashing, INCREASE DOWN (close) force** by turning the control clockwise. Make small adjustments until the door completes a close cycle. After each adjustment, run the opener through a complete travel cycle. Do not increase the force beyond the minimum amount required to close the door.

### 2. Test the **UP (open) force**

- Grasp the door bottom when the door is about halfway through UP (open) travel. The door should stop. **If the door is hard to hold or doesn't stop, DECREASE UP (open) force** by turning the control counterclockwise. Make small adjustments until the door stops easily and opens fully. After each adjustment, run the opener through a complete travel cycle.
- **If the door doesn't open at least 5 feet (1.5 m), INCREASE UP (open) force** by turning the control clockwise. Make small adjustments until door opens completely. Readjust the UP limit if necessary. After each adjustment, run the opener through a complete travel cycle.

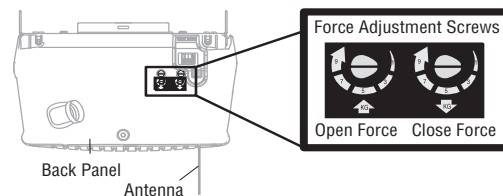

# Adjustments

## STEP 3 Test the Safety Reversal System

### **WARNING**

Without a properly installed safety reversal system, persons (particularly small children) could be **SERIOUSLY INJURED** or **KILLED** by a closing garage door.

- Safety reversal system **MUST** be tested every month.
- After **ANY** adjustments are made, the safety reversal system **MUST** be tested. Door **MUST** reverse on contact with 1-1/2" (3.8 cm) high object (or 2x4 laid flat) on the floor.

1. With the door fully open, place a 1-1/2 inch (3.8 cm) board (or a 2x4 laid flat) on the floor, centered under the garage door.
2. Press the remote control push button to close the door. The door **MUST** reverse when it makes contact with the board.

If the door stops and does not reverse on the obstruction, the down travel needs to be increased (refer to Adjustment Step 1). Repeat the test. When the door reverses upon contact with the 1-1/2 inch board, remove the board and open/close the door 3 or 4 times to test the adjustment. If the garage door opener continues to fail the safety reversal test, call a trained door systems technician.

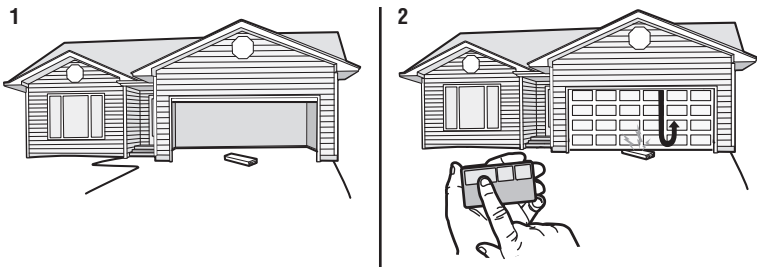

## STEP 4 Test the Protector System®

### **WARNING**

Without a properly installed safety reversing sensor, persons (particularly small children) could be **SERIOUSLY INJURED** or **KILLED** by a closing garage door.

1. Open the door. Place the garage door opener carton in the path of the door.
2. Press the remote control push button to close the door. The door will not move more than an inch (2.5 cm), and the garage door opener lights will flash 10 times.

The garage door opener will not close from a remote control if the LED in either safety reversing sensor is off (alerting you to the fact that the sensor is misaligned or obstructed). If the garage door opener closes the door when the safety reversing sensor is obstructed (and the sensors are no more than 6 inches [15 cm] above the floor), call for a trained door systems technician.

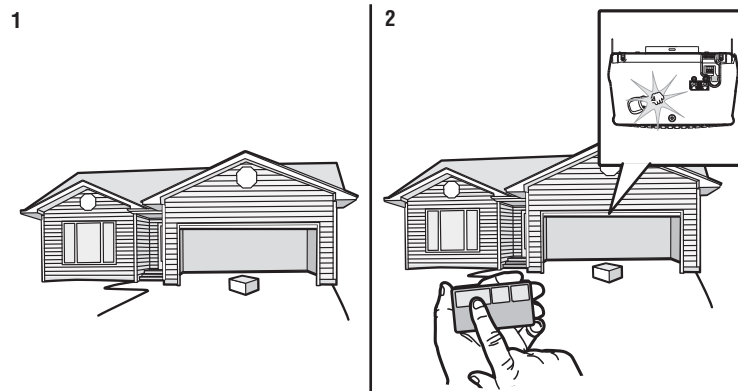

# IMPORTANT SAFETY INSTRUCTIONS



## To reduce the risk of SEVERE INJURY or DEATH:

1. READ AND FOLLOW ALL WARNINGS AND INSTRUCTIONS.
  2. ALWAYS keep remote controls out of reach of children. NEVER permit children to operate or play with garage door control push buttons or remote controls.
  3. ONLY activate garage door when it can be seen clearly, it is properly adjusted, and there are no obstructions to door travel.
  4. ALWAYS keep garage door in sight and away from people and objects until completely closed. NO ONE SHOULD CROSS THE PATH OF THE MOVING DOOR.
  5. NO ONE SHOULD GO UNDER A STOPPED, PARTIALLY OPENED DOOR.
  6. If possible, use emergency release handle to disengage trolley ONLY when garage door is CLOSED. Use caution when using the release with the door opener. Weak or broken springs or unbalanced door could result in an open door falling rapidly and/or unexpectedly and increasing the risk of SEVERE INJURY or DEATH.
  7. NEVER use emergency release handle unless garage doorway is clear of persons and obstructions.
  8. NEVER use handle to pull garage door open or closed. If rope knot becomes untied, you could fall.
  9. After ANY adjustments are made, the safety reversal system MUST be tested.
  10. Safety reversal system MUST be tested every month. Garage door MUST reverse on contact with 1-1/2" (3.8 cm) high object (or a 2x4 laid flat) on the floor. Failure to adjust the garage door opener properly increases the risk of SEVERE INJURY or DEATH.
  11. ALWAYS KEEP GARAGE DOOR PROPERLY BALANCED (see page 2). An improperly balanced door may NOT reverse when required and could result in SEVERE INJURY or DEATH.
  12. ALL repairs to cables, spring assemblies and other hardware, ALL of which are under EXTREME tension, MUST be made by a trained door systems technician.
  13. ALWAYS disconnect electric power to garage door opener BEFORE making ANY repairs or removing covers.
  14. This operator system is equipped with an unattended operation feature. The door could move unexpectedly. NO ONE SHOULD CROSS THE PATH OF THE MOVING DOOR.
- 15. SAVE THESE INSTRUCTIONS.**



# Operation

## Using Your Garage Door Opener

Your Security+® opener and hand-held remote control have been factory-set to a matching code which changes with each use, randomly accessing over 100 billion new codes. Your opener will operate with up to eight Security+® remote controls and one Security+® Keyless Entry System. If you purchase a new remote, or if you wish to deactivate any remote, follow the instructions in the Programming section.

### Activate your opener with any of the following:

- The Hand-Held Remote Control: Hold the large push button down until the door starts to move.
- The Wall-Mounted Door Control: Hold the push button or bar down until the door starts to move.
- The Keyless Entry (See Accessories): If provided with your garage door opener, it must be programmed before use. See Programming.

### When the opener is activated (with the safety reversing sensor correctly installed and aligned)

1. If open, the door will close. If closed, it will open.
2. If closing, the door will reverse.
3. If opening, the door will stop.
4. If the door has been stopped in a partially open position, it will close.
5. If obstructed while closing, the door will reverse. If the obstruction interrupts the sensor beam, the opener lights will blink for five seconds.
6. If obstructed while opening, the door will stop.
7. If fully open, the door will not close when the beam is broken. The sensor has no effect in the opening cycle.

If the sensor is not installed, or is misaligned, the door won't close from a hand-held remote. However, you can close the door with the Door Control, the Outside Keylock, or Keyless Entry, if you activate them until down travel is complete. If you release them too soon, the door will reverse.

**The opener light** will turn on under the following conditions: when the opener is initially plugged in; when power is restored after interruption; when the opener is activated.

They will turn off automatically after 4-1/2 minutes. Bulb size is A19. Bulb power is 100 watts maximum.

**Security+® light feature:** Lights will also turn on when someone walks through the open garage door. With a Multi-Function Door Control, this feature may be turned off as follows: With the opener lights off, press and hold the light button for 10 seconds, until the light goes on, then off again. To restore this feature, start with the opener lights on, then press and hold the light button for 10 seconds until the light goes off, then on again.

## Using the Wall-Mounted Door Control

### Door Control Button

Press the lighted push button to open or close the door. Press again to reverse the door during the closing cycle or to stop the door while it's opening.

### The Multi-Function Door Control

Press the push bar/push button to open or close the door. Press again to reverse the door during the closing cycle or to stop the door while it's opening.

### Light Feature

Press the Light button to turn the opener light on or off. It will not control the opener lights when the door is in motion. If you turn it on and then activate the opener, the light will remain on for 4-1/2 minutes. Press again to turn it off sooner. The 4-1/2 minute interval can be changed to 1-1/2, 2-1/2, or 3-1/2 minutes as follows:

1. Press and hold the Lock button until the light blinks (about 10 seconds). A single blink indicates that the timer is reset to 1-1/2 minutes.
2. Repeat the procedure and the light will blink twice, resetting the timer to 2-1/2 minutes.
3. Repeat again for a 3-1/2 minute interval, etc., up to a maximum of four blinks and 4-1/2 minutes.

### Lock Feature

Designed to prevent operation of the door from handheld remote controls. However, the door will open and close from the Door Control, the Outside Keylock and the Keyless Entry Accessories.

To activate, press and hold the Lock button for 2 seconds. The push bar light will flash as long as the Lock feature is on.

To turn off, press and hold the Lock button again for 2 seconds. The push bar light will stop flashing. The Lock feature will also turn off whenever the "Learn" button on the motor unit panel is activated.

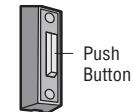
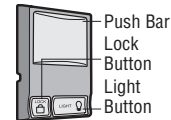

# Operation

## To Open the Door Manually

### **WARNING**

To prevent possible **SERIOUS INJURY** or **DEATH** from a falling garage door:

- If possible, use emergency release handle to disengage trolley **ONLY** when garage door is **CLOSED**. Weak or broken springs or unbalanced door could result in an open door falling rapidly and/or unexpectedly.
- **NEVER** use emergency release handle unless garage doorway is clear of persons and obstructions.
- **NEVER** use handle to pull door open or closed. If rope knot becomes untied, you could fall.

### DISCONNECT THE TROLLEY

1. The door should be fully closed if possible.
2. Pull down on the emergency release handle so the trolley release arm snaps to the vertical position. The door can now be raised and lowered as often as necessary.

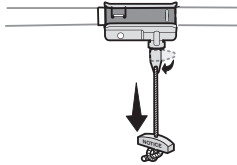

### RECONNECT THE TROLLEY

1. Pull the emergency release handle toward the garage door opener so the trolley release arm snaps to the horizontal position. The trolley will reconnect on the next UP or DOWN operation, either manually or by using the door control or remote control.

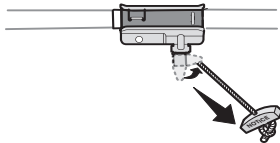

## Care of Your Opener

### LIMIT AND FORCE ADJUSTMENTS

Weather conditions may cause some minor changes in door operation requiring some re-adjustments, particularly during the first year of operation. Pages 28 and 29 refer to the limit and force adjustments.

Only a screwdriver is required. Follow the instructions carefully. Repeat the safety reverse test (Adjustment Step 3, page 30) after any adjustment of limits or force.

### FORCE CONTROLS



### LIMIT CONTROLS



### MAINTENANCE SCHEDULE

#### Every Month

- Manually operate door. If it is unbalanced or binding, call a trained door systems technician.
- Check to be sure door opens and closes fully. Adjust limits and/or force if necessary (see pages 28 and 29).
- Repeat the safety reverse test. Make any necessary adjustments (see Adjustment Step 3).

#### Two Times a Year

- Check chain tension. Disconnect trolley first. Adjust if necessary (see page 9).

#### Every Year

- Oil door rollers, bearings and hinges. The opener does not require additional lubrication. Do not grease the door tracks.

# Operation

## Having a Problem?

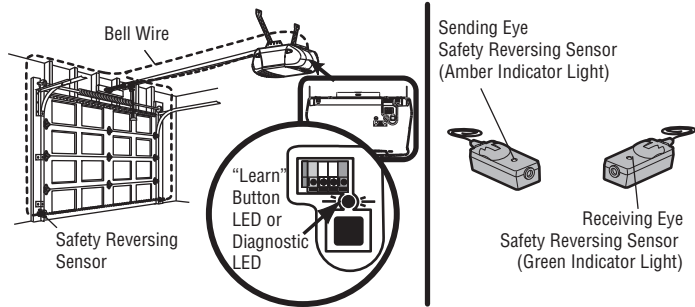

- 1. My door will not close and the light bulbs blink on my motor unit: The safety reversing sensor must be connected and aligned correctly before the garage door opener will move in the down direction.**
  - Verify the safety reversing sensors are properly installed, aligned and free of any obstructions. Refer to *Installation Step 13: Install The Protector System®*.
  - Check diagnostic LED for flashes on the motor unit then refer to the *Diagnostic Chart* on the following page.
- 2. My remotes will not activate the door:**
  - Verify your Multi-Function Door Control is not blinking. If it is blinking, deactivate the Lock Mode following the instructions for *Using the Multi-Function Door Control*.
  - Reprogram remotes following the programming instructions. Refer to *Programming*.
  - If remote will still not activate your door, check diagnostic LED for flashes on motor unit then refer to *Diagnostic Chart* on the following page.
- 3. My door reverses for no apparent reason:** Repeat safety reverse test after adjustments to force or travel limits. The need for occasional adjustment for the force and limit settings is normal. Weather conditions in particular can affect door travel.
  - Manually check door for balance or any binding problems.
  - Refer to *Adjustment Step 2, Adjust the force*.

- 4. My door reverses for no apparent reason after fully closing and touching the floor:** Repeat safety reverse test after adjustments to force or travel limits. The need for occasional adjustment for the force and limit settings is normal. Weather conditions in particular can affect door travel.
  - Refer to *Adjustment Step 1, Adjust the UP and DOWN Travel Limits*. Decrease down travel by turning down limit adjustment screw clockwise.
- 5. My lights will not turn off when door is open:**
  - The garage door opener is equipped with a security light feature. This feature activates the light on when the safety reversing sensor beam has been obstructed. Refer to Operation section; *Using the Wall-Mounted Door Control, Light Feature*.
- 6. My motor unit hums briefly:**
  - First verify that the trolley is against the stop bolt.
  - Release the door from the opener by pulling the Emergency Release Rope.
  - Manually bring the door to a closed position.
  - Loosen the chain by adjusting the *outer nut* 4 to 5 turns. This relieves the tension.
  - Run the motor unit from the remote control or door control. The trolley should travel towards the door and stop. If the trolley re-engages with the door, pull the Emergency Release Rope to disengage.
  - Decrease the UP travel by turning the UP Travel adjustment screw 2 full turns *away* from the arrow.
  - Re-tighten the outer nut so the chain is a 1/4" (6 mm) above the base of the rail. (When the door is reconnected and closed, the chain will sag. This is normal.)
  - If the trolley does not move away from the bolt, repeat the steps above.

# Operation

## Diagnostic Chart

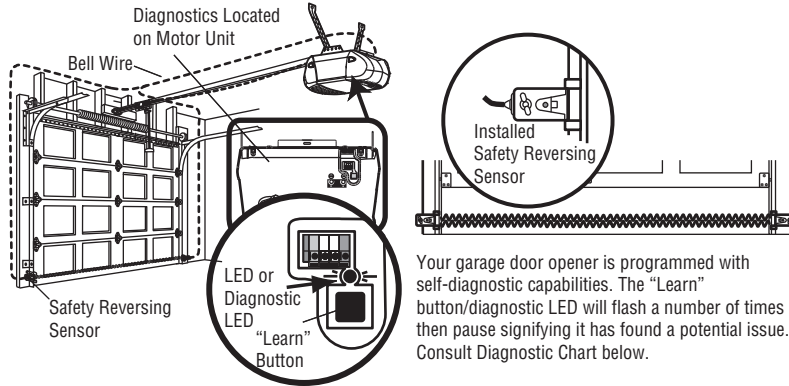

<b>1 Flash</b>	<p><b>Symptom:</b> One or both of the indicator lights on the safety reversing sensors do not glow steady.</p> <ul style="list-style-type: none"> <li>Inspect sensor wires for a short (staple in wire), correct wiring polarity (black/white wires reversed), broken or disconnected wires, replace/attach as needed.</li> <li>Disconnect all wires from back of motor unit.</li> <li>Remove sensors from brackets and shorten sensor wires to 1-2 ft. (30-60 cm) from back each of sensor.</li> <li>Reattach sending eye to motor unit using shortened wires. If sending eye indicator light glows steadily, attach the receiving eye.</li> <li>Align sensors, if the indicator lights glow replace the wires for the sensors. If the sensor indicator lights do not light, replace the safety reversing sensors.</li> </ul>
<b>2 Flashes</b>	<p>Safety reversing sensors wire open (broken or disconnected). OR Safety reversing sensors wire shorted or black/white wire reversed.</p>

<b>3 Flashes</b>	<p><b>Symptom:</b> LED is not lit on door control.</p> <p>Door control or wire shorted.</p> <ul style="list-style-type: none"> <li>Inspect door control/wires for a short (staple in wire), replace as needed.</li> <li>Disconnect wires at door control, touch wires together. If motor unit activates, replace door control.</li> <li>If motor unit does not activate, disconnect door control wires from motor unit. Momentarily short across red and white terminals with jumper wire. If motor unit activates, replace door control wires.</li> </ul>
<b>4 Flashes</b>	<p><b>Symptom:</b> Sending indicator light glows steadily, receiving indicator light is dim or flashing.</p> <p>Safety reversing sensors slightly misaligned (dim or flashing LED).</p> <ul style="list-style-type: none"> <li>Realign receiving eye sensor, clean lens and secure brackets.</li> <li>Verify door track is firmly secured to wall and does not move.</li> </ul>
<b>5 Flashes</b>	<p><b>Symptom:</b> Motor has over heated; the motor unit does not operate or trolley is stuck on stop bolt = Motor unit hums briefly; RPM Sensor = Short travel 6-8" (15-20 cm).</p> <p>Motor overheated or possible RPM sensor failure. Unplug to reset.</p> <ul style="list-style-type: none"> <li>Unplug unit to reset. Try to operate motor unit, check diagnostic code.</li> <li>If it is still flashing 5 times and motor unit moves 6-8" (15-20 cm), replace RPM sensor.</li> <li>If motor unit doesn't operate, motor unit is overheated. Wait 30 minutes and retry. If motor unit still will not operate replace logic board.</li> </ul>
<b>6 Flashes</b>	<p><b>Symptom:</b> Motor unit doesn't operate.</p> <p>Motor Circuit Failure. Replace Receiver Logic Board.</p> <ul style="list-style-type: none"> <li>Replace logic board because motor rarely fails.</li> </ul>

# Operation

## Programming

**NOTICE:** If this Security+® garage door opener is operated with a non-rolling code transmitter, the technical measure in the receiver of the garage door opener, which provides security against code-theft devices, will be circumvented. The owner of the copyright in the garage door opener does not authorize the purchaser or supplier of the non-rolling code transmitter to circumvent that technical measure.

### PROGRAM A REMOTE CONTROL USING THE LEARN BUTTON

1. Locate the Learn Button.
2. Press and immediately release the Learn button. The Learn LED will glow steady for 30 seconds. Within 30 seconds...
3. Press and hold the button on the remote control that you wish to use. Release the button when the garage door opener lights blink or two clicks are heard. When replacing the light lens cover, ensure the antenna wires are hanging straight down.

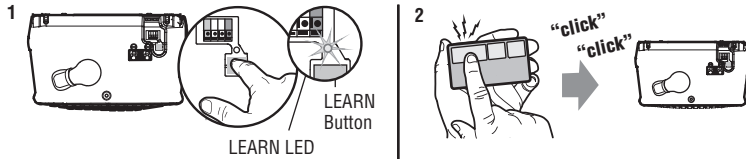

### PROGRAM A REMOTE CONTROL USING THE MULTI-FUNCTION DOOR CONTROL

1. Press and hold the button on the hand-held remote\* that you wish to operate your garage door.
2. While holding the remote button, press and hold the LIGHT button on the Multi-Function Door Control. Continue holding both buttons while you press the push bar on the Multi-Function Door Control (all three buttons are held).
3. Release buttons when the motor unit lights blink. It has learned the code. If light bulbs are not installed, two clicks will be heard.

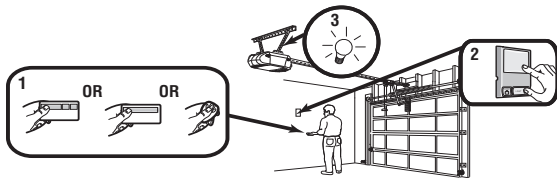

## To Erase the Memory

### ERASE ALL REMOTE CONTROLS AND KEYLESS ENTRIES

1. Press and hold the learn button on garage door opener until the learn LED goes out (approximately 6 seconds). All remote control and keyless entry codes are now erased. Reprogram any accessory you wish to use.

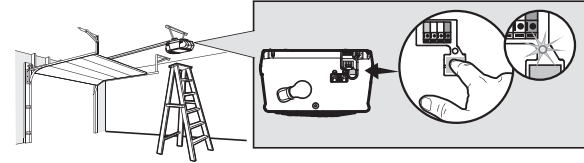

### \*3-BUTTON REMOTES

If provided with your garage door opener, the large button is factory programmed to operate it. Additional buttons on any Security+® 3-Button remote or compact remote can be programmed to operate other Security+® garage door openers.

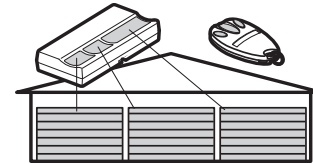

# Operation

## Programming

### To Add, Reprogram or Change a Keyless Entry PIN

**NOTE:** Your new Keyless Entry must be programmed to operate your garage door opener.

#### USING THE "LEARN" BUTTON

1. Press and release the "learn" button on motor unit. The learn indicator light will glow steadily for 30 seconds.
2. Within 30 seconds, enter a four digit personal identification number (PIN) of your choice on the keypad. Then press and hold the ENTER button.
3. Release the button when the motor unit lights blink. It has learned the code. If light bulbs are not installed, two clicks will be heard.

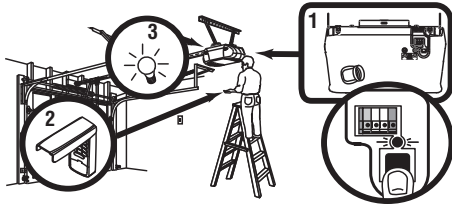

#### USING THE MULTI-FUNCTION DOOR CONTROL

1. Enter a four digit personal identification number (PIN) of your choice on the keypad. Then press and hold ENTER.
2. While holding the ENTER button, press and hold the LIGHT button on the Multi-Function Door Control. Continue holding the ENTER and LIGHT buttons while you press the push bar on the Multi-Function Door Control (all three buttons are held).
3. Release buttons when the motor unit lights blink. It has learned the code. If light bulbs are not installed, two clicks will be heard.

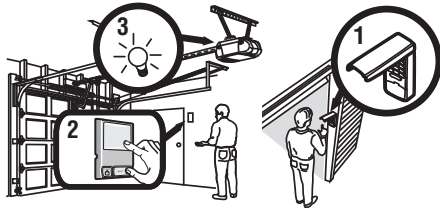

#### To change an existing, known PIN

If the existing PIN is known, it may be changed by one person without using a ladder.

1. Press the four buttons for the present PIN, then press and hold the # button. The opener light will blink twice. Release the # button.
2. Press the new 4-digit PIN you have chosen, then press Enter. The motor unit lights will blink once when the PIN has been learned. Test by pressing the new PIN, then press Enter. The door should move.

#### To set a temporary PIN

You may authorize access by visitors or service people with a temporary 4-digit PIN. After a programmed number of hours or number of accesses, this temporary PIN expires and will no longer open the door. It can be used to close the door even after it has expired. To set a temporary PIN:

1. Press the four buttons for your personal entry PIN (not the last temporary PIN), then press and hold the \* button. The opener light will blink three times. Release the button.
2. Press the temporary 4-digit PIN you have chosen, then press Enter. The opener light will blink four times.
3. To set the number of hours this temporary PIN will work, press the number of hours (up to 255), then press \*.

#### OR

1. To set the number of times this temporary PIN will work, press the number of times (up to 255), then press #.

The opener light will blink once when the temporary PIN has been learned.

Test by pressing the four buttons for the temporary PIN, then press Enter. The door should move. If the temporary

PIN was set to a certain number of openings, remember that the test has used up one opening. To clear the temporary password, repeat steps 1-3, setting the number of hours or times to 0 in step 3.

**One Button Close:** Opener can be closed by pressing only the ENTER button if the one button close feature has been activated. This feature has been activated at the factory. To activate or deactivate this feature press and hold buttons 1 and 9 for 10 seconds. The keypad will blink twice when the one button close is active. The keypad will blink four times when one button close is deactivated.

# Operation

## The Remote Control Battery

### **WARNING**

To prevent possible **SERIOUS INJURY** or **DEATH**:

- NEVER allow small children near batteries.
- If battery is swallowed, immediately notify doctor.

To reduce risk of fire, explosion or chemical burn:

- Replace **ONLY** with 3V2032 coin batteries.
- **DO NOT** recharge, disassemble, heat above 212°F (100°C) or incinerate.

The lithium battery should produce power for up to 5 years.

To replace battery, use the visor clip or screwdriver blade to pry open the case as shown. Insert battery positive side up (+).

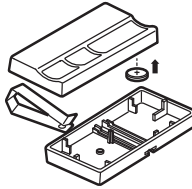

**NOTICE:** To comply with FCC and/or Industry Canada (IC) rules, adjustment or modifications of this receiver and/or transmitter are prohibited, except for changing the code setting or replacing the battery. THERE ARE NO OTHER USER SERVICEABLE PARTS.

Tested to Comply with FCC Standards FOR HOME OR OFFICE USE. Operation is subject to the following two conditions: (1) this device may not cause harmful interference, and (2) this device must accept any interference received, including interference that may cause undesired operation.

# Accessories

**7702CB Outside Quick Release:**  
Required for a garage with NO access door.



**41A5281 Extension Brackets:**  
(Optional) For safety reversing sensor installation onto the wall or floor.



**CLSS1 System Surge Protector:**  
The Garage Door Opener Surge Protector is designed to protect Chamberlain garage door openers against damage from lighting and power surges. Easy to install.



**953D SECURITY+® 3-Button Remote Control** (📶):  
Includes visor clip.

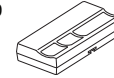

**7708CB 8 Foot (2.4 m) Rail Extension:**  
To allow an 8 foot (2.4 m) door to open fully.

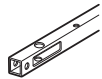

**CLLAD Remote Light Control** (📶):  
(Optional) For safety reversing sensor installation onto the wall or floor.



**CLDM1 Garage Door Monitor:**  
Monitors the status of your garage door from inside your home.



**956D SECURITY+® 3-Button Mini-Remote Control** (📶):  
With key ring and fastening strip.



**7710CB 10 Foot (3 m) Rail Extension:**  
To allow an 10 foot (3 m) door to open fully.

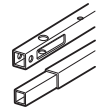

**CLLP1 Laser Parking Assistant:**  
Park in the right spot every time! A laser beam is activated by your garage door opener and projected on to the dashboard of your vehicle to guide perfect parking.



**BIK01 Installation Upgrade Kit:**  
The Installation Upgrade Kit includes all components needed to hang garage door openers up to 24" (61 cm) from the ceiling.



**940D SECURITY+® Keyless Entry** (📶):  
Enables homeowner to operate garage door opener from outside by entering a password on a specially designed keyboard. Also can add a temporary password for visitors or service persons. This temporary password can be limited to a programmable number of hours or entries.





# Warranty

## **CHAMBERLAIN® 1 YEAR LIMITED WARRANTY 6 YEAR MOTOR LIMITED WARRANTY PD210D, PD212D, PD300, 248730, LW2000 & HD200D**

The Chamberlain Group, Inc. ("Seller") warrants to the first retail purchaser of this product, for the residence in which this product is originally installed, that it is free from defect in materials and/or workmanship for a period of 1 YEAR from the date of purchase and that the MOTOR is free from defect in materials and/or workmanship for a period of 6 YEARS from the date of purchase. The proper operation of this product is dependent on your compliance with the instructions regarding installation, operation, maintenance and testing. Failure to comply strictly with those instructions will void this limited warranty in its entirety.

If, during the limited warranty period, this product appears to contain a defect covered by this limited warranty, call 1-800-528-9131, toll free, before dismantling this product. Then send this product, pre-paid and insured, to our service center for warranty repair. You will be advised of shipping instructions when you call. Please include a brief description of the problem and a dated proof-of-purchase receipt with any product returned for warranty repair.

Products returned to Seller for warranty repair, which upon receipt by Seller are confirmed to be defective and covered by this limited warranty, will be repaired or replaced (at Seller's sole option) at no cost to you and returned pre-paid. Defective parts will be repaired or replaced with new or factory-rebuilt parts at Seller's sole option.

**ALL IMPLIED WARRANTIES FOR THE PRODUCT, INCLUDING BUT NOT LIMITED TO ANY IMPLIED WARRANTIES OF MERCHANTABILITY AND FITNESS FOR A PARTICULAR PURPOSE, ARE LIMITED IN DURATION TO THE 1 YEAR LIMITED WARRANTY PERIOD SET FORTH ABOVE EXCEPT THE IMPLIED WARRANTIES WITH RESPECT TO THE MOTOR, WHICH ARE LIMITED IN DURATION TO THE 6 YEARS LIMITED WARRANTY PERIOD FOR THE MOTOR, AND NO IMPLIED WARRANTIES WILL EXIST OR APPLY AFTER SUCH PERIOD.** Some States do not allow limitations on how long an implied warranty lasts, so the above limitation may not apply to you.

**THIS LIMITED WARRANTY DOES NOT COVER NON-DEFECT DAMAGE, DAMAGE CAUSED BY IMPROPER INSTALLATION, OPERATION OR CARE (INCLUDING, BUT NOT LIMITED TO ABUSE, MISUSE, FAILURE TO PROVIDE REASONABLE AND NECESSARY MAINTENANCE, UNAUTHORIZED REPAIRS OR ANY ALTERATIONS TO THIS PRODUCT), LABOR CHARGES FOR REINSTALLING A REPAIRED OR REPLACED UNIT, REPLACEMENT OF BATTERIES AND LIGHT BULBS OR UNITS INSTALLED FOR NONRESIDENTIAL USE. THIS LIMITED WARRANTY DOES NOT COVER ANY PROBLEMS WITH, OR RELATING TO, THE GARAGE DOOR OR GARAGE DOOR HARDWARE, INCLUDING BUT NOT LIMITED TO THE DOOR SPRINGS, DOOR ROLLERS, DOOR ALIGNMENT OR HINGES. THIS LIMITED WARRANTY ALSO DOES NOT COVER ANY PROBLEMS CAUSED BY INTERFERENCE. ANY SERVICE CALL THAT DETERMINES THE PROBLEM HAS BEEN CAUSED BY ANY OF THESE ITEMS COULD RESULT IN A FEE TO YOU.**

**UNDER NO CIRCUMSTANCES SHALL SELLER BE LIABLE FOR CONSEQUENTIAL, INCIDENTAL OR SPECIAL DAMAGES ARISING IN CONNECTION WITH USE, OR INABILITY TO USE, THIS PRODUCT. IN NO EVENT SHALL SELLER'S LIABILITY FOR BREACH OF WARRANTY, BREACH OF CONTRACT, NEGLIGENCE OR STRICT LIABILITY EXCEED THE COST OF THE PRODUCT COVERED HEREBY. NO PERSON IS AUTHORIZED TO ASSUME FOR US ANY OTHER LIABILITY IN CONNECTION WITH THE SALE OF THIS PRODUCT.**

Some states do not allow the exclusion or limitation of consequential, incidental or special damages, so the above limitation or exclusion may not apply to you. This limited warranty gives you specific legal rights, and you may also have other rights which vary from state to state.

## **CHAMBERLAIN® 1 YEAR LIMITED WARRANTY LIFETIME MOTOR LIMITED WARRANTY PD610D & PD612D**

The Chamberlain Group, Inc. ("Seller") warrants to the first retail purchaser of this product, for the residence in which this product is originally installed, that it is free from defect in materials and/or workmanship for a period of 1 YEAR from the date of purchase and that the MOTOR is free from defect in materials and/or workmanship for the lifetime of the product. The proper operation of this product is dependent on your compliance with the instructions regarding installation, operation, maintenance and testing. Failure to comply strictly with those instructions will void this limited warranty in its entirety.

If, during the limited warranty period, this product appears to contain a defect covered by this limited warranty, call 1-800-528-9131, toll free, before dismantling this product. Then send this product, pre-paid and insured, to our service center for warranty repair. You will be advised of shipping instructions when you call. Please include a brief description of the problem and a dated proof-of-purchase receipt with any product returned for warranty repair.

Products returned to Seller for warranty repair, which upon receipt by Seller are confirmed to be defective and covered by this limited warranty, will be repaired or replaced (at Seller's sole option) at no cost to you and returned pre-paid. Defective parts will be repaired or replaced with new or factory-rebuilt parts at Seller's sole option.

**ALL IMPLIED WARRANTIES FOR THE PRODUCT, INCLUDING BUT NOT LIMITED TO ANY IMPLIED WARRANTIES OF MERCHANTABILITY AND FITNESS FOR A PARTICULAR PURPOSE, ARE LIMITED IN DURATION TO THE 1 YEAR LIMITED WARRANTY PERIOD SET FORTH ABOVE EXCEPT THE IMPLIED WARRANTIES WITH RESPECT TO THE MOTOR, WHICH ARE LIMITED IN DURATION TO THE LIFETIME LIMITED WARRANTY PERIOD FOR THE MOTOR, AND NO IMPLIED WARRANTIES WILL EXIST OR APPLY AFTER SUCH PERIOD.** Some States do not allow limitations on how long an implied warranty lasts, so the above limitation may not apply to you.

**THIS LIMITED WARRANTY DOES NOT COVER NON-DEFECT DAMAGE, DAMAGE CAUSED BY IMPROPER INSTALLATION, OPERATION OR CARE (INCLUDING, BUT NOT LIMITED TO ABUSE, MISUSE, FAILURE TO PROVIDE REASONABLE AND NECESSARY MAINTENANCE, UNAUTHORIZED REPAIRS OR ANY ALTERATIONS TO THIS PRODUCT), LABOR CHARGES FOR REINSTALLING A REPAIRED OR REPLACED UNIT, REPLACEMENT OF BATTERIES AND LIGHT BULBS OR UNITS INSTALLED FOR NONRESIDENTIAL USE. THIS LIMITED WARRANTY DOES NOT COVER ANY PROBLEMS WITH, OR RELATING TO, THE GARAGE DOOR OR GARAGE DOOR HARDWARE, INCLUDING BUT NOT LIMITED TO THE DOOR SPRINGS, DOOR ROLLERS, DOOR ALIGNMENT OR HINGES. THIS LIMITED WARRANTY ALSO DOES NOT COVER ANY PROBLEMS CAUSED BY INTERFERENCE. ANY SERVICE CALL THAT DETERMINES THE PROBLEM HAS BEEN CAUSED BY ANY OF THESE ITEMS COULD RESULT IN A FEE TO YOU.**

**UNDER NO CIRCUMSTANCES SHALL SELLER BE LIABLE FOR CONSEQUENTIAL, INCIDENTAL OR SPECIAL DAMAGES ARISING IN CONNECTION WITH USE, OR INABILITY TO USE, THIS PRODUCT. IN NO EVENT SHALL SELLER'S LIABILITY FOR BREACH OF WARRANTY, BREACH OF CONTRACT, NEGLIGENCE OR STRICT LIABILITY EXCEED THE COST OF THE PRODUCT COVERED HEREBY. NO PERSON IS AUTHORIZED TO ASSUME FOR US ANY OTHER LIABILITY IN CONNECTION WITH THE SALE OF THIS PRODUCT.**

Some states do not allow the exclusion or limitation of consequential, incidental or special damages, so the above limitation or exclusion may not apply to you. This limited warranty gives you specific legal rights, and you may also have other rights which vary from state to state.

# Warranty

## CHAMBERLAIN® TWO-YEAR LIMITED WARRANTY

### TEN-YEAR MOTOR LIMITED WARRANTY HD400D & LW3000

The Chamberlain Group, Inc. ("Seller") warrants to the first retail purchaser of this product, for the residence in which this product is originally installed, that it is free from defect in materials and/or workmanship for a period of two years from the date of purchase and that the motor is free from defect in materials and/or workmanship for a period of ten years from the date of purchase. The proper operation of this product is dependent on your compliance with the instructions regarding installation, operation, maintenance and testing. Failure to comply strictly with those instructions will void this limited warranty in its entirety.

If, during the limited warranty period, this product appears to contain a defect covered by this limited warranty, call 1-800-528-9131, toll free, before dismantling this product. Then send this product, pre-paid and insured, to our service center for warranty repair. You will be advised of shipping instructions when you call. Please include a brief description of the problem and a dated proof-of-purchase receipt with any product returned for warranty repair. Products returned to Seller for warranty repair, which upon receipt by Seller are confirmed to be defective and covered by this limited warranty, will be repaired or replaced (at Seller's sole option) at no cost to you and returned pre-paid. Defective parts will be repaired or replaced with new or factory-rebuilt parts at Seller's sole option.

**ALL IMPLIED WARRANTIES FOR THE PRODUCT, INCLUDING BUT NOT LIMITED TO ANY IMPLIED WARRANTIES OF MERCHANTABILITY AND FITNESS FOR A PARTICULAR PURPOSE, ARE LIMITED IN DURATION TO THE TWO-YEAR LIMITED WARRANTY PERIOD SET FORTH ABOVE EXCEPT THE IMPLIED WARRANTIES WITH RESPECT TO THE MOTOR, WHICH ARE LIMITED IN DURATION TO THE TEN-YEAR LIMITED WARRANTY PERIOD FOR THE MOTOR, AND NO IMPLIED WARRANTIES WILL EXIST OR APPLY AFTER SUCH PERIOD. Some States do not allow limitations on how long an implied warranty lasts, so the above limitation may not apply to you.**

**THIS LIMITED WARRANTY DOES NOT COVER NON-DEFECT DAMAGE, DAMAGE CAUSED BY IMPROPER INSTALLATION, OPERATION OR CARE (INCLUDING, BUT NOT LIMITED TO ABUSE, MISUSE, FAILURE TO PROVIDE REASONABLE AND NECESSARY MAINTENANCE, UNAUTHORIZED REPAIRS OR ANY ALTERATIONS TO THIS PRODUCT), LABOR CHARGES FOR REINSTALLING A REPAIRED OR REPLACED UNIT, REPLACEMENT OF BATTERIES AND LIGHT BULBS OR UNITS INSTALLED FOR NON-RESIDENTIAL USE. THIS LIMITED WARRANTY DOES NOT COVER ANY PROBLEMS WITH, OR RELATING TO, THE GARAGE DOOR OR GARAGE DOOR HARDWARE, INCLUDING BUT NOT LIMITED TO THE DOOR SPRINGS, DOOR ROLLERS, DOOR ALIGNMENT OR HINGES. THIS LIMITED WARRANTY ALSO DOES NOT COVER ANY PROBLEMS CAUSED BY INTERFERENCE. ANY SERVICE CALL THAT DETERMINES THE PROBLEM HAS BEEN CAUSED BY ANY OF THESE ITEMS COULD RESULT IN A FEE TO YOU.**

**UNDER NO CIRCUMSTANCES SHALL SELLER BE LIABLE FOR CONSEQUENTIAL, INCIDENTAL OR SPECIAL DAMAGES ARISING IN CONNECTION WITH USE, OR INABILITY TO USE, THIS PRODUCT. IN NO EVENT SHALL SELLER'S LIABILITY FOR BREACH OF WARRANTY, BREACH OF CONTRACT, NEGLIGENCE OR STRICT LIABILITY EXCEED THE COST OF THE PRODUCT COVERED HEREBY. NO PERSON IS AUTHORIZED TO ASSUME FOR US ANY OTHER LIABILITY IN CONNECTION WITH THE SALE OF THIS PRODUCT.**

Some states do not allow the exclusion or limitation of consequential, incidental or special damages, so the above limitation or exclusion may not apply to you. This limited warranty gives you specific legal rights, and you may also have other rights which vary from state to state.

# Repair Parts

## Rail Assembly Parts

Description	Part Number
1 Chain and Cable	41A5807
2 Pulley	144C56
3 Master Link	4A1008
4 Rail	41A5665
5 Trolley Assembly	41C5141-1
6 "U" Bracket	12D598-1
<b>Not Shown</b>	
Wear Pads	183A163
Hardware Bag	041A7920-1
Owner's Manual	114A4254

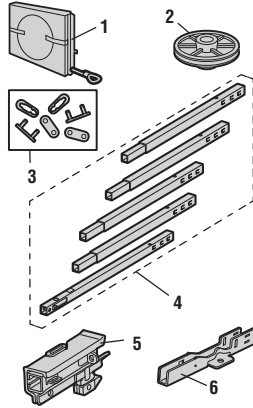

## Accessories

Description	Part Number
1 Door Control Button	41A4166
2 Multi-Function Door Control Panel	41C494-2
3 Single-button Remote Control	950D
4 3-Button Remote Control	953D

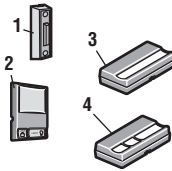

## Installation Parts

Description	Part Number
1 Curved Door Arm	178B35
2 Door Bracket with Clevis Pin and Fastener	41A5047-1
3 Emergency Release Rope and Handle	41A2828
4 Header Bracket with Clevis Pin and Fastener	41A5047-2
5 Remote Control Visor Clip	29B137
6 Safety Sensor Bracket	41A5266-1
7 Safety Sensor Kit Receiving and sending sensors with wire	41A5034
8 Straight Door Arm	178B34
9 White and Red/White Wire	41B4494-1
10 3V2030 Lithium Battery	10A20
11 Hanging Brackets	12B776

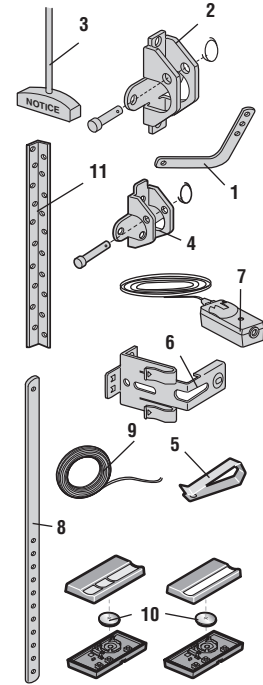

## Contact Information

For installation and service information call:

**1-800-528-9131**

Before calling, please have the model number of the garage door opener. If you are calling about a Troubleshooting issue, it is recommended that you have access to your garage door opener while calling. If you are ordering a repair part please have the following information: part number, part name, and model number.

Address repair parts orders to:  
**The Chamberlain Group, Inc.**  
**6050 S. Country Club Rd.**  
**Tucson, AZ 85706**

# Repair Parts

## Garage Door Opener Parts

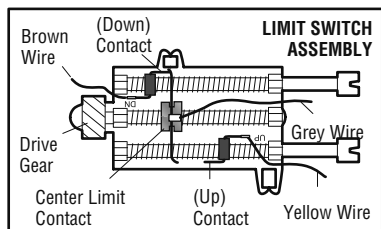
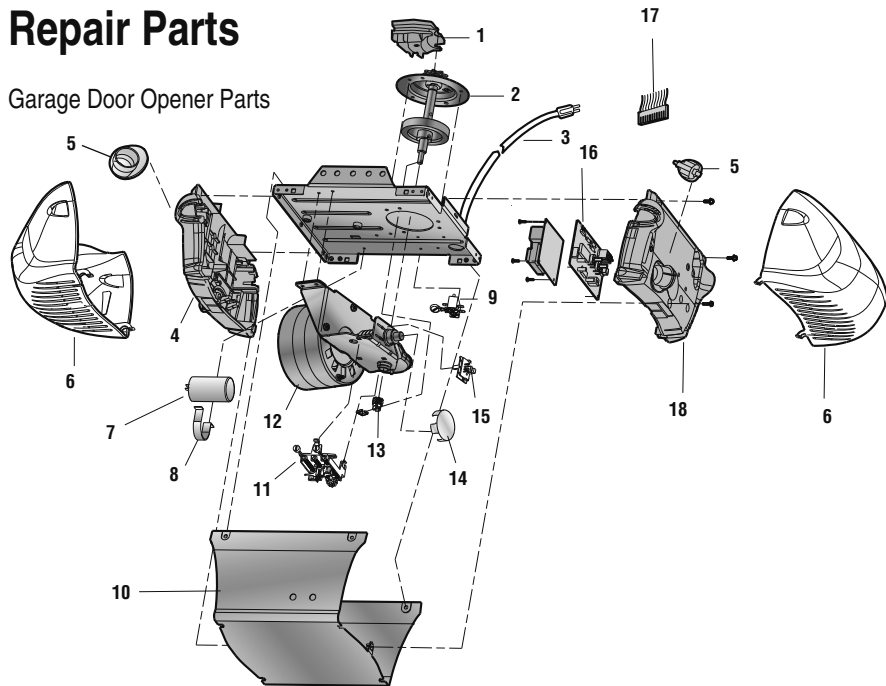

Description		Part Number
1	Chain Spreader	41A5615
2	Gear and Sprocket	41C4220A
3	Line Cord	41B4245
4	End Panel Models PD610D/PD612D/HD400D/LW3000 Models PD210D/PD212D/PD300/LW2000/HD200D/248730	41A5484-1 41D181
5	Light Socket	4A1344
6	Light Lens	108D79
7	Capacitor	30B532
8	Capacitor Bracket	12A373
9	Terminal Block with Screws	41A3150
10	Cover	41A5525-5
11	Limit Switch Assembly	41D3452
12	Universal Motor	41D3058
13	Limit Switch	41A2818
14	Interrupter Cup Assembly	41A2822-1
15	RPM Sensor	41C4398
16	Receiver Logic Board Models PD210D/PD212D/PD300/HD200D/248730/LW2000 Models PD610D/PD612D/HD400D/LW3000	41AC050-1M 41AC050-2M
17	High Voltage Wire Harness Low Voltage Wire Harness	41C5497 41C5498
18	End Panel for Receiver Logic Board Models PD610D/PD612D/HD400D/LW3000 Models PD210D/PD212D/PD300/LW2000/HD200D/248730	41D180-1 41A5484-1
<b>Not Shown</b>		
	Motor Shaft Bearing Kit	41A2826